

SKIPPER

Graphic Depth Sounder

GDS101

Operation and Installation Manual

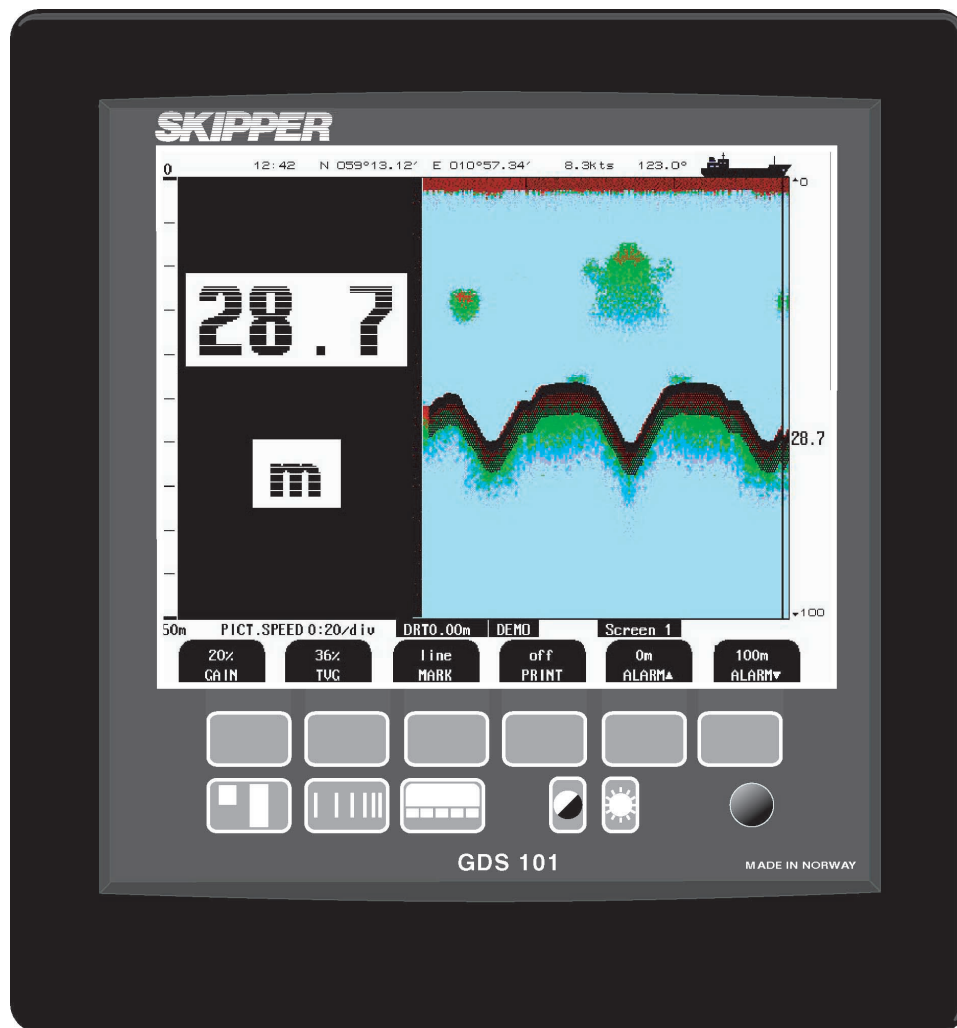

SKIPPER Electronics AS
Enebakkveien 150
P. O. Box 151, Manglerud
0612 Oslo, Norway
www.skipper.no

Telephone: +47 23 30 22 70
Telefax: +47 23 30 22 71
E-mail: support@skipper.no
Co. reg. no: NO-965378847-MVA

Document no: **DM-G001-SB**
Edition: 2012-10-02
Rev 05.05.16

Information:

Please visit our web site www.skipper.no for additional information. Here you will find product bulletins, software updates, instruction manuals, installation procedures etc.

Weitergabe sowie vervielfältigung dieser unterlage, verwertung und mitteilung ihres inhaltes nicht gestattet, soweit nicht ausdrücklich zugestanden. Zuwiderhandlungen verpflichten zu schadenersatz.

Toute communication ou reproduction de ce document, toute exploitation ou communication de ou son contenu sont interdites, sauf autorisation expresse. Tout manquement à cette règle est illicite et expose son auteur au versement de dommages et intérêts.

Copying of this document, and giving it to others and the use or communication of contents thereof, are forbidden without express authority. Offenders are liable to the payment of damages.

Sin nuestra expresa autorización, queda terminantemente prohibida la reproducción total o parcial de este documento, así como su uso indebido y/o su exhibición o comunicación a terceros. De los infractores Se exigirá el correspondiente resarcimiento de daños y perjuicios.

Contents

1. INTRODUCTION.....	6
System Summary	6
Transducers	6
Operator Panel and Data Entry	6
Recorded Data Storage	7
Fig. 1.1 Main Display Unit Panel Layout.....	7
Fig. 1.2 System Diagram	8
Interfacing	9
Outputs	9
Inputs.....	9
Alarms.....	9
Options.....	9
Repeaters.....	9
Remote Sounding Control.....	9
Autorange.....	9
Sound Speed Calibration.....	9
Fig. 1.3 GDS101 Primary Functions.....	10
2. OPERATION.....	11
Parameter entry	11
Fig. 2.1 Setting and Parameter Entry Flowchart.....	11
Example of parameter entry	12
Operation Screens	12
Primary Operation Screens	13
Fig. 2.2. Screen 1, Primary Operation screen.....	13
Fig. 2.3. Screen 2, 2nd Operation screen.....	14
Fig. 2.4. Screen 3, 3rd Operation screen.	15
Secondary Operation Screens	16
Fig. 2.5. Screen 4, Calendar and clock setting.	16
Fig. 2.6. Screen 5, Language and units of measure setup.....	17
Fig. 2.7. Screen 6, Interface setup screen.	18
Fig. 2.8. Screen 7, History Memory Control Screen.....	19
Fig. 2.9. Screen 8, NMEA control screen.....	20
Fig. 2.10. Screen 9, System status screen.....	21
Fig. 2.11. Screen 10, Oscilloscope screen.	22
Principal Functions	23
Bottom detection	23
Ping to Ping filtering	23
Bottom Search Range.....	23
System (Power) On/Off.....	23
Remaining disk size diagnostics	23
Fixed Key Functions	24
Depth Range.....	24
Picture Speed.....	24
Screen Select	24
Day/Night and back light adjustment (brightness).....	24
Soft key Functions	25
Gain	25
TVG.....	25
Digital indication.....	25
Frequency.....	25
Output Power	25
Draught.....	25

External Printer Operation	26
Alarm Settings.....	26
Alarm acknowledgement	27
Alarm ID	27
Audio warning.....	27
Clock and Calendar Settings	27
History Memory	27
Simulator.....	28
Status Screen	28
Oscilloscope Screen	28
Nonvolatile Flash Parameter Memory	28
Options	28
Repeaters/Slaves	28
Remote Sounding Control.....	28
Auto Range.....	29
Sound Speed Calibration.....	29
External Printer	29
3. USER MAINTENANCE	30
Transducer Maintenance	30
Operator Unit Maintenance.....	30
Typical Status Screen (9) Contents.....	31
Typical Oscilloscope Screen (10) Contents	33
4. INSTALLATION	35
Standard System Supply	35
Transducer Installation.....	35
Location.....	35
Installation Details	35
Fig. 4.1. Basic System Configuration.	36
Transducer Junction Box	37
Fig. 4.2. Transducer Junction Box.....	37
Operator Unit Installation	38
Fig. 4.3. Operator Unit.....	38
115/230 V Selection	39
EMC.....	39
Fig. 4.4. Voltage selection connectors and fuses, terminal board.	40
Fig. 4.5. History Memory Battery Jumper, I/O Board.....	41
Fig. 4.6 Function LEDs, Terminal, I/O and CPU Boards.....	42
Fig. 4.7. Main Wiring Diagram.....	43
Fig. 4.8. Input/Output Circuitry.	44
Interfacing.....	45
Alarm relay.....	45
External alarm reset function	45
Log Pulse input	45
Remote Transducer Selector FEEDB (Feedback).....	45
Transmitter trigger pulse and bottom pulse outputs.....	46
Analogue interfaces.....	46
NMEA interface	46
Fig. 4.9. NMEA connector XJ303.....	46
Fig. 4.10. Data Communication Interfaces.....	47
Fig. 4.11. Alarm interconnections	48
External Interface Ports.....	49
Fig. 4.12. External Interface Ports	49
Options.....	50
Repeaters/Slaves	50

Remote Keyboard.....	50
Remote Sounding Control.....	50
5. START-UP AND SYSTEM ADAPTION.....	51
System Adaptation	51
Analogue Output and Log Pulse Input Range Selection.....	51
Language and Units of Measure	51
Remote Transducer Selector	51
Low frequency indication	51
NMEA Setup	52
NMEA transmitted/output messages.....	52
NMEA received/input messages	53
Options.....	54
Calibration, Sound Speed.....	54
External Ping Control.....	54
6. SPECIFICATIONS, DIMENSIONS	55
Transducer and Junction Box.....	57
Operator Unit Cabinet.....	57
7. SERVICE.....	58
8. CPU BOARD SETUP PROCEDURE.....	59
CPU PCA 6742VE.....	59
Master Reset Procedure	60
Upgrading Software	60
9. APPENDIX, MISCELLANEOUS DRAWINGS.....	61
Fig. 9.1 Transducer Selector Connection	62
Fig. 9.2 Transducer Selector	63
Fig. 9.3 Cable Gland Connection.....	64
Fig. 9.4 EMC Mounting Kit.....	65
10. WARRANTY AND UTILIZATION	66
Warranty:.....	66
Utilization:	66
11. NOTES	67
12. INDEX.....	68

1. Introduction

System Summary

GDS101 is a navigation echo sounder with a large high resolution graphic LCD. The echo sounder graphics are continuously shown on the LCD along with complete navigational details.

The colour bar:

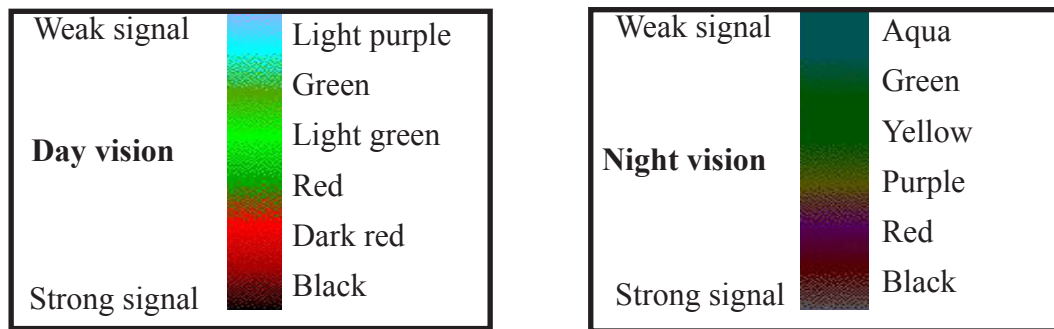

It is possible to connect an external printer to the operator unit. The sounder contains a 24 hour history memory that can be printed out. Depth, time and all available navigation data are stored continuously so that the last 24 hours of information is always available. All this information may also be printed on the external printer. All IMO requirements are met or exceeded. Comprehensive interfaces are available including IEC 61162-1:2007(E) (NMEA 0183) inputs and outputs.

Transducers

GDS101 is prepared for connection to transducers of the following frequencies: 38, 50 and 200 kHz. One or more of the transducers may be connected at the same time, and the desired transducer may be selected from the operator panel.

Operator Panel and Data Entry

The operator unit contains a graphic LCD and a keyboard with fixed keys, soft keys and a rotating encoder. The function of each soft key button depends on the active screen, and the buttons are labeled on the lower rim of the LCD. The display is backlit, and contrast and backlight intensity may be adjusted by the user. The echogram is displayed continuously on the LCD and stored in the 24 hour history memory. An optional external printer is used if hard-copy documentation is required. The operator unit is normally flush mounted. Power supply options are 115/230 V AC or 24 V DC. The power consumption is app. 70 Watt at 115/230 V AC or 50 Watt at 24 V DC.

Several screens may be selected to enter various settings and parameters. Each screen has a selection of soft key buttons. Screens 1 through 3 are primary operation screens with appropriate operator controls. Screens 4 through 10 are parameter setup and system supervision screens. The various screens will be described in detail later.

Recorded Data Storage

The measured depth and other navigational data is continuously stored in the 24 hour history memory. A standard printer HP Deskjet or Epson D88/LQ300 (all with Centronics parallel interface) may be connected for paper copy. Ask local representative or manufacturer for specifications. (Contact details on title page).

Warning!

False bottom echoes may occur when:

- The bottom is out of range.
- Extreme noise conditions are present.
- Bottom signal may be lost for other reasons, like wakes or aeration below transducer.

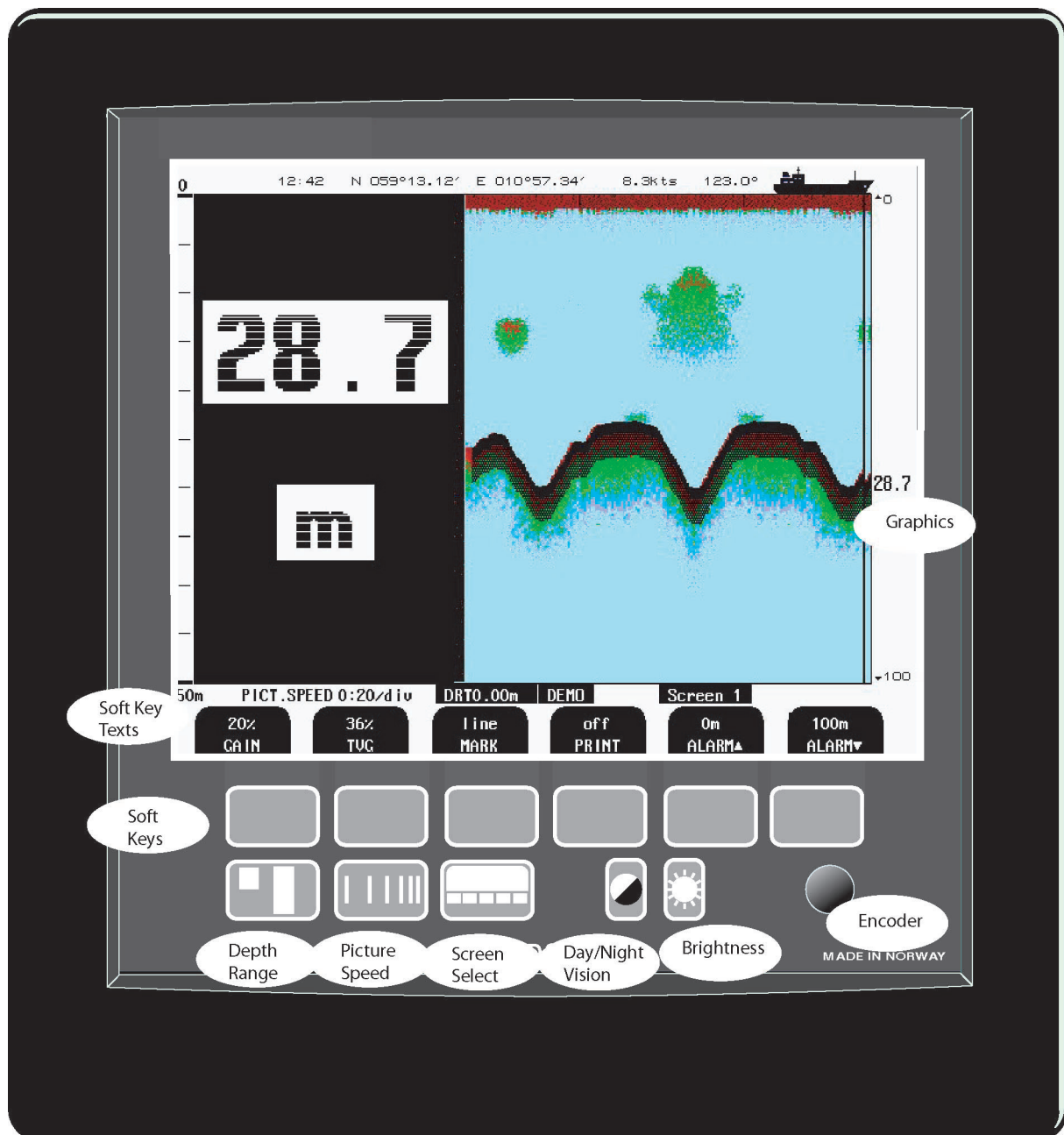

Fig. 1.1 Main Display Unit Panel Layout

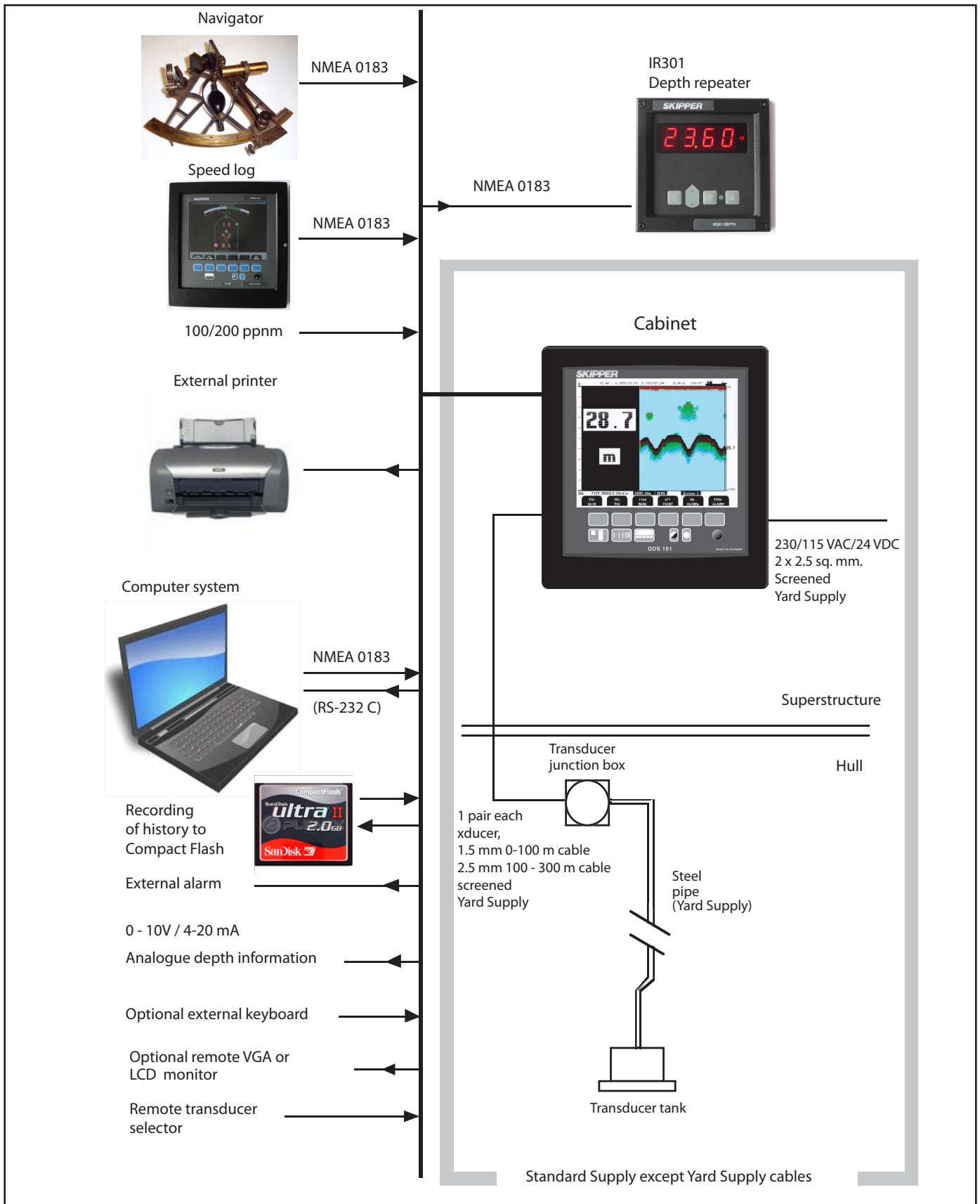

Fig. 1.2 System Diagram

Interfacing

The GDS101 has several interface possibilities.

Outputs

- Transmitter trigger pulse and bottom pulse outputs. See “[Transmitter trigger pulse and bottom pulse outputs](#)” on page 46.
- Analogue output 0 - 10 V or 4 - 20 mA. See “[Analogue interfaces](#)” on page 46.
- IEC 61162-1:2007(E) (NMEA 0183). See “[NMEA interface](#)” on page 46.
- External alarm relay output. See “[Alarm relay](#)” on page 45.
- External printer. See “[External Interface Ports](#)” on page 49.
- External VGA monitor. See “[External Interface Ports](#)” on page 49.

Inputs

- Log input 100/200/400/20000 pulses per nautical mile. See “[Log Pulse input](#)” on page 45.
- IEC 61162-1:2007(E) (NMEA 0183) interface input of position, heading, speed and UTC. See “[NMEA Setup](#)” on page 52.
- Remote control and synchronisation of transmitter. (Option). See “[External Ping Control](#)” on page 54.
- Remote transducer switch. See “[Fig. 9.2 Transducer Selector](#)” on page 63.
- Remote keyboard. See “[Remote Keyboard](#)” on page 50.
- External alarm reset. See “[External alarm reset function](#)” on page 45.

Alarms

Shallow and deep water alarms may be selected from screen 1. See “[Fig. 2.2. Screen 1, Primary Operation screen.](#)” on page 13. A potential free relay contact is provided in GDS101 for interface to external alarm systems.

Options

Repeaters

Graphic CRT, LCD display or digital depth slave repeaters may be connected to the system. Along with the graphic display repeaters, there may also be installed a remote keyboard.

Remote Sounding Control

* This option lets the GDS101 being remote controlled in synchronized, burst or single ping modes.

Autorange

This option will automatically adjust the depth range to maintain the bottom contour within the middle half of the screen.

Sound Speed Calibration

* This option will enable adjustment of the sound speed value used for the depth calculations.

***Note:** These options can not be used with IMO approval.

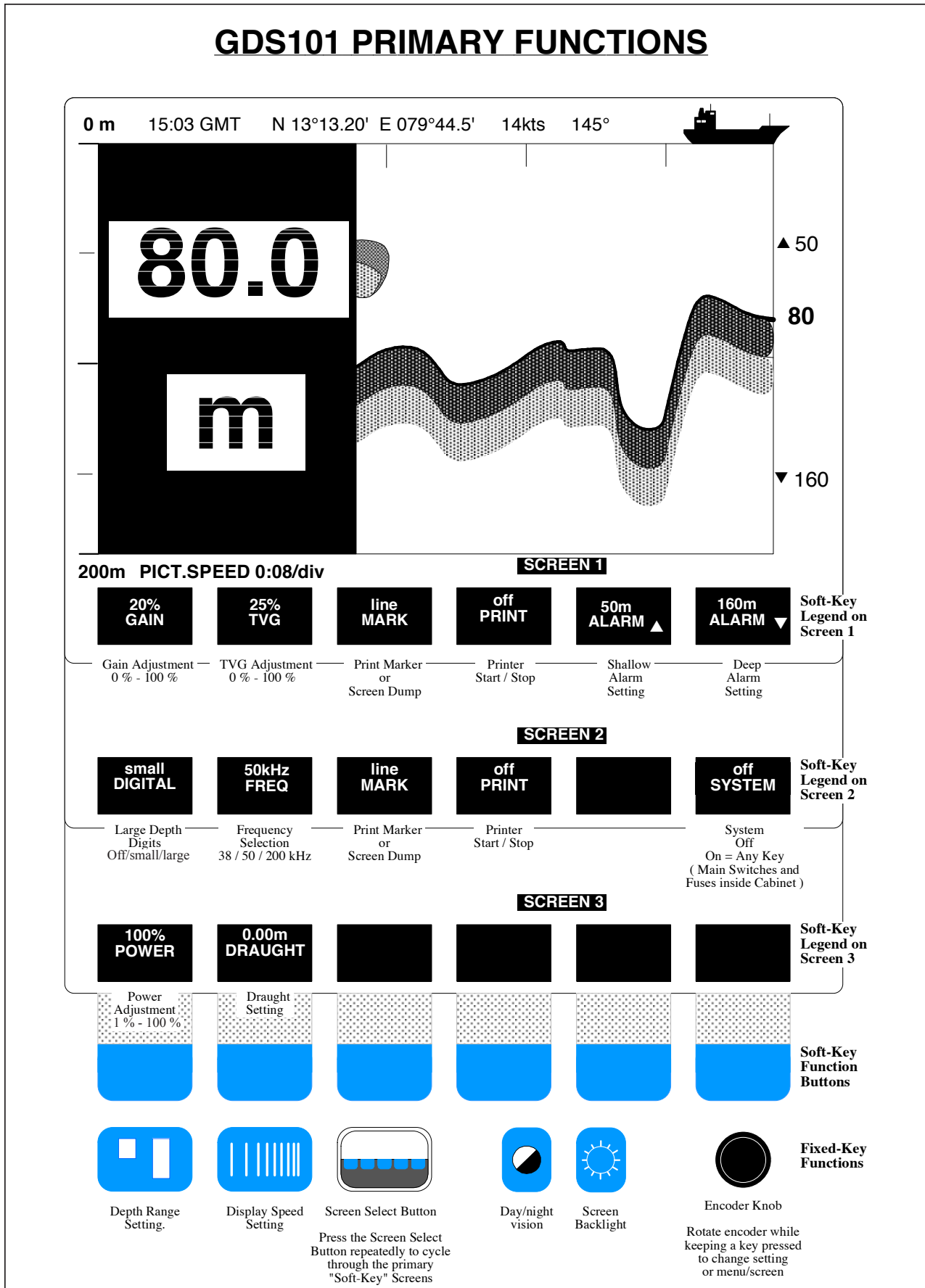

Fig. 1.3 GDS101 Primary Functions

2. Operation

When the installation is complete, and power is connected to the operator unit, the system is switched on-off by power switch(es) inside the cabinet. See “[Fig. 4.4. Voltage selection connectors and fuses, terminal board.](#)” on page 40.

Parameter entry

The fixed function and soft key buttons of the various screens along with the rotating encoder, facilitates entry of parameters, setpoints and other data. The following flowchart illustrates the procedure for changing settings and entering data. The various screens are shown in detail in the operation section.

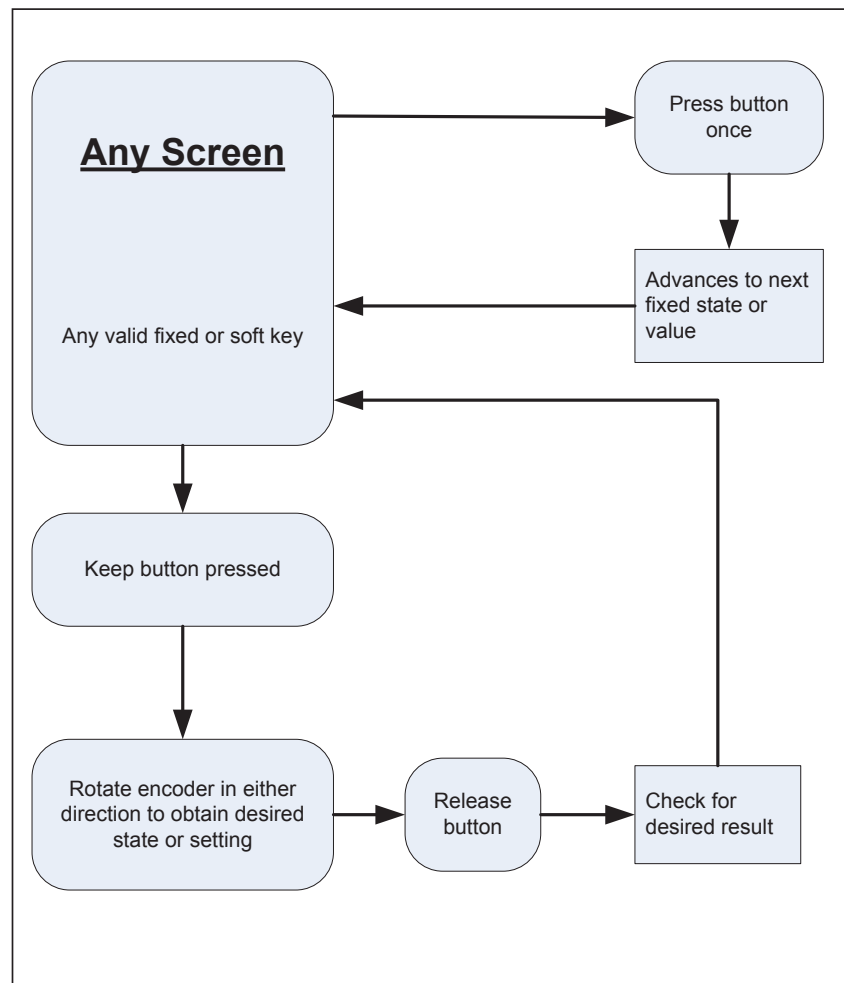

Fig. 2.1 Setting and Parameter Entry Flowchart

Example of parameter entry

Suppose you want to enter a value of 800 m for the depth range. Press the DEPTH RANGE button several times and observe the depth range sequencing through the standard values 10, 50, 100, 500, 1000 m. Press till the range is 500 m. Then press the DEPTH RANGE button again and keep it pressed while you turn the encoder clockwise. Observe the depth range increase to 800 m, release the encoder and the DEPTH RANGE button. You could also have started from the standard value 1000 m and decreased to 800 m by turning the encoder counter-clockwise.

Operation Screens

Each of the operation screens contains a graphic picture and a selection of up to 6 soft key buttons. The various screens are selected by keeping the SCREEN SELECT button pressed and rotating the encoder in either direction. Turning the encoder clockwise cycle the screens in the sequence 1 to 10, and counter clockwise rotation cycles the screens in the sequence 10 to 1. Screens no. 1, 2 and 3, covering the primary functions, may also be cycled by repeatedly pressing the SCREEN SELECT button.

The screen layouts are outlined in fig. 2.2 through 2.11. The various soft key functions are described with each screen.

Primary Operation Screens

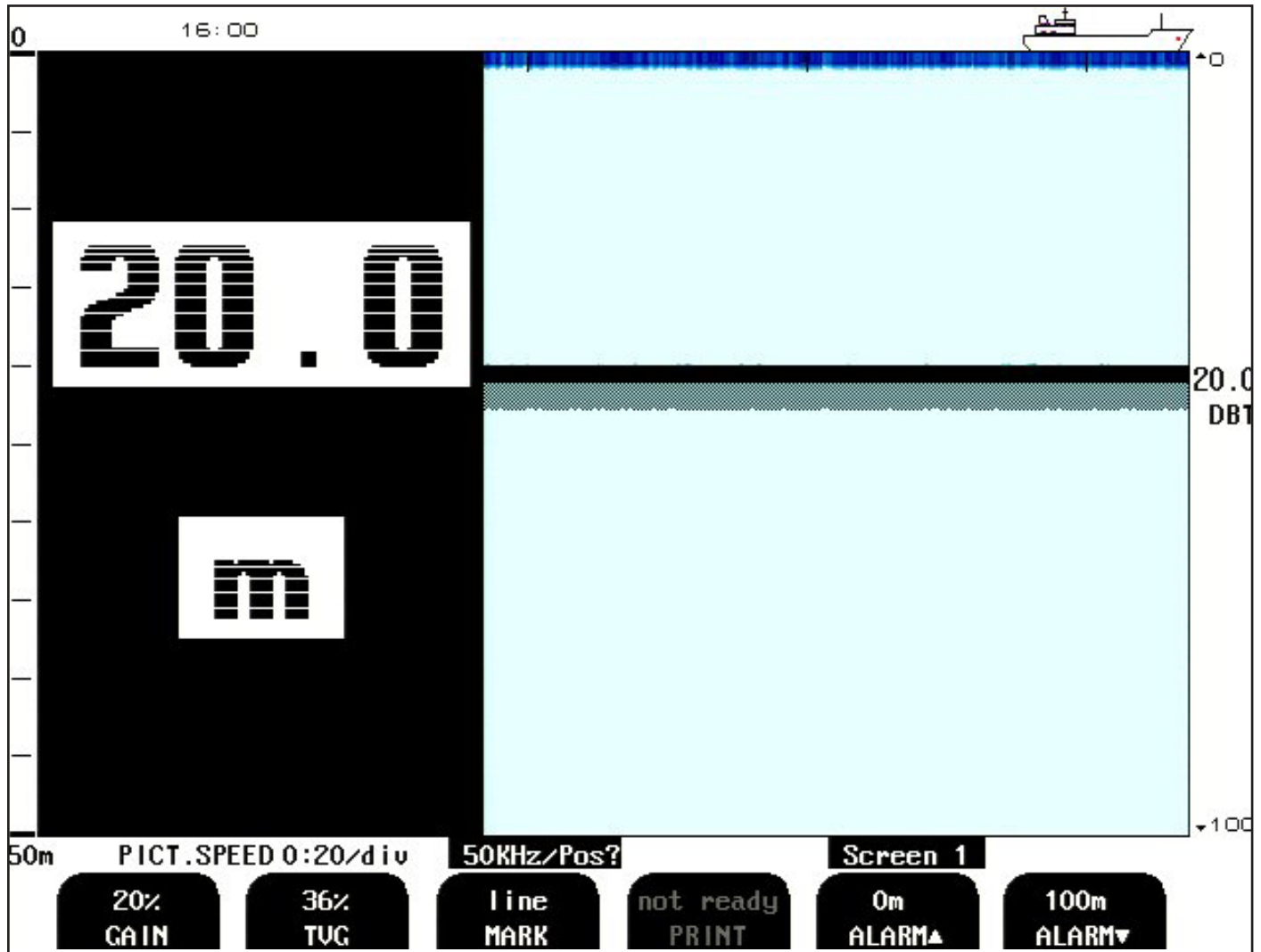

Fig. 2.2. Screen 1, Primary Operation screen.

This screen shows the main graphic echo gram. Left hand digital indication may be enabled from screen 2.

Soft key	Name	Range/value	Default value	Description
1	GAIN	0 - 100 %	20 %	Gain adjustment. (100 % is max. gain). See “Gain” on page 25.
2	TVG	0 - 100 %	36 %	Time Variable Gain adjustment. (0 % is max suppression). Suppression of echoes from 0 - 40 meter. See “TVG” on page 25.
3	MARK	Line		Print mark line/print screen.
4	PRINT	On/off	Off	Start and stop of continuous printing. (If printer is switched off or not connected, this button is “Dimmed”).
5	ALARM ▲	0 - 100 m	0 m	Shallow water alarm adjustment. See “Alarm Settings” on page 26.
6	ALARM ▼	0 - 1600 m	100 m	Deep water alarm adjustment. See “Alarm Settings” on page 26.

The currently selected transducer (frequency) is indicated at the bottom of all screens along with optional transducer position, e.g. 200 kHz/FWD. (DRT0.00 m and 200 kHz/FWD are toggling with 1 sec. interval.) Selection of the transducer position reference is performed in screen 10. See [“Fig. 2.11. Screen 10, Oscilloscope screen.” on page 22.](#)

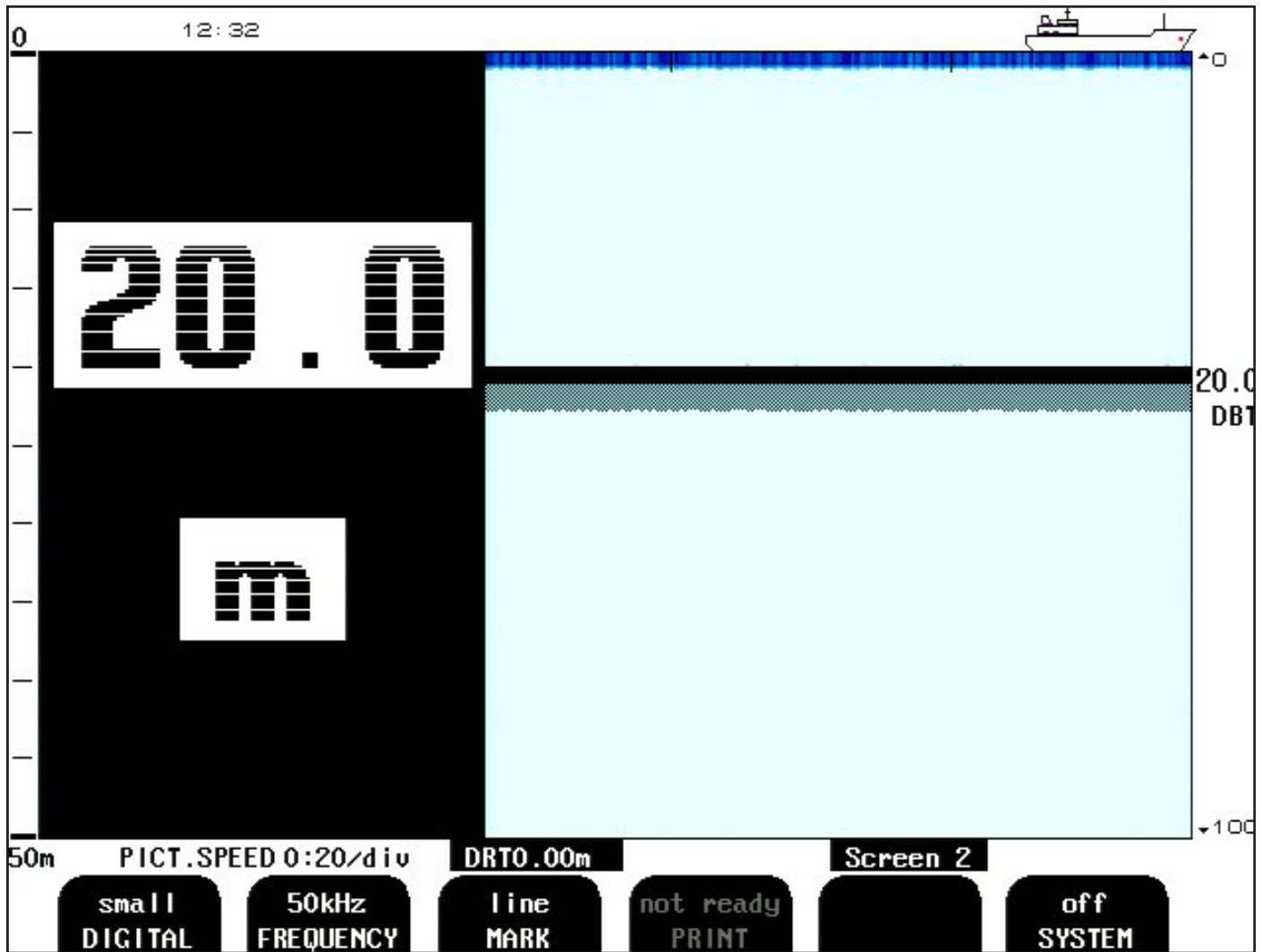

Fig. 2.3. Screen 2, 2nd Operation screen.

This screen shows the main graphic echo gram. Left hand digital indication may be enabled from this screen.

Soft key	Name	Range/value	Default value	Description
1	DIGITAL	Off, small, large	Off	Control of digital depth indication.
2	FREQUENCY	38*/50/200 kHz	50 kHz	Transducer selection. (Have to be “installed “ in screen 10, soft key 2 and 3). See “ Fig. 2.11. Screen 10, Oscilloscope screen. ” on page 22.
3	MARK	Line		Print mark line/dump screen.
4	PRINT	On/off	Off	Start and stop of continuous printing. (If printer is switched off or not connected, this button is “Dimmed”).
5				Not used.
6	SYSTEM	On/off	On	Switch system off. Switch on with any button. (NOTE: There is still power on the GDS101).

* Note: 38 kHz may vary if other frequency options are installed.

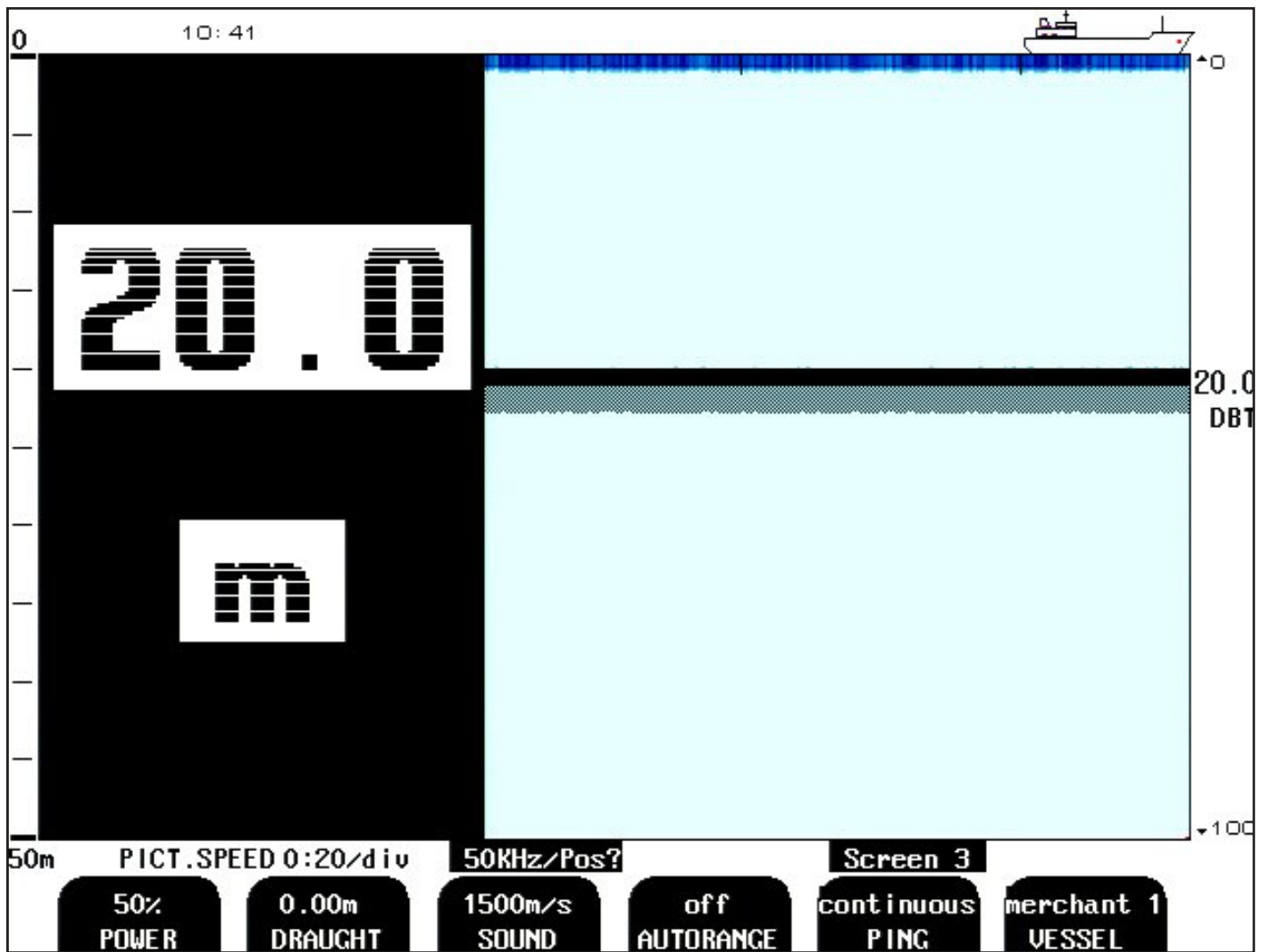

Fig. 2.4. Screen 3, 3rd Operation screen.

This screen shows the main graphic echo gram. Left hand digital indication may be enabled from screen 2.

Soft key	Name	Range/value	Default value	Description
1	POWER	1 - 100 %	50 %	Transmitter power adjustment. See " Output Power " on page 25.
2	DRAUGHT	-99.99 - 99.9 m	0.00 m	Draught correction, must be set individually for each frequency. For draught, see " Draught " on page 25.
3 (Option)	SOUND	1400 - 1550 m/s	1500 m/s	Sound speed setting, (option).
4 (Option)	AUTORANGE	On/off	Off	Autorange control, (option).
5 (Option)	PING	Continuous, edge, level, single	Continuous	Ping control, (option). See " External Ping Control " on page 54.
6 (Option)	VESSEL	Merchant 1, merchant 2, navy 1, navy 2	Merchant 1	Upper right screen icon selection, (option).

Note: Soft keys 3, 4 and 5 controls optional functions.

Note: If options are installed afterwards by changing the logic on the I/O board, it is also possible here on screen 3 to select vessel icon (soft key 6).

Secondary Operation Screens

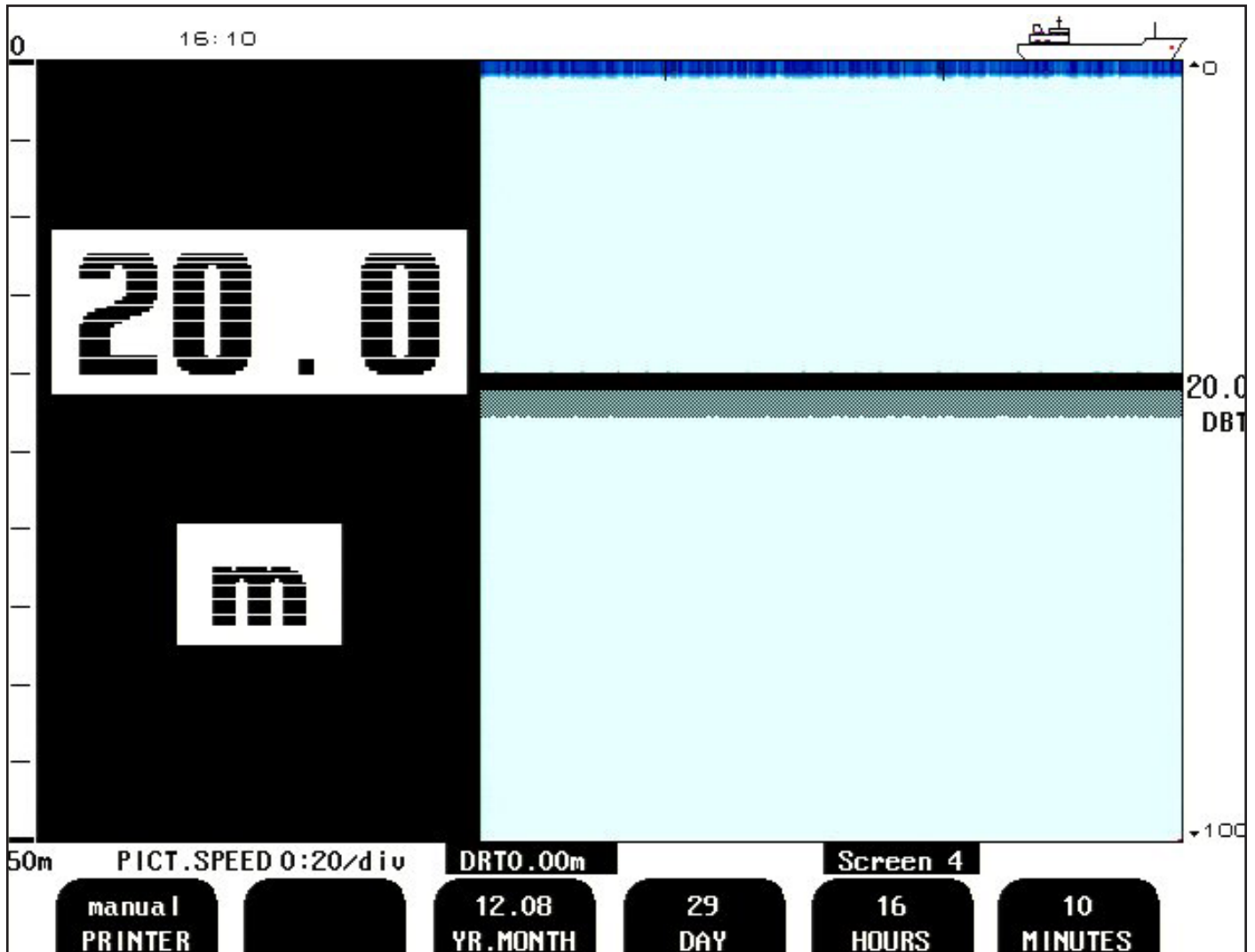

Fig. 2.5. Screen 4, Calendar and clock setting.

This screen shows the main graphic echo gram. Left hand digital indication may be enabled from screen 2.

Soft key	Name	Range/value	Default value	Description
1	PRINTER	Manual/auto	Manual	External printer start options. Auto: Printer start, if depth alarm is activated.
2				Not used.
3	Y(EA)R.MONTH	01.03 ->		Calendar year setting.
4	DAY	1 - 31		Calendar day setting.
5	HOURS	0 - 23		Real time clock hours setting.
6	MINUTES	0 - 59		Real time clock minutes setting.

Note: If GPS is connected, soft key 3, 4, 5 and 6 are controlled by GPS.

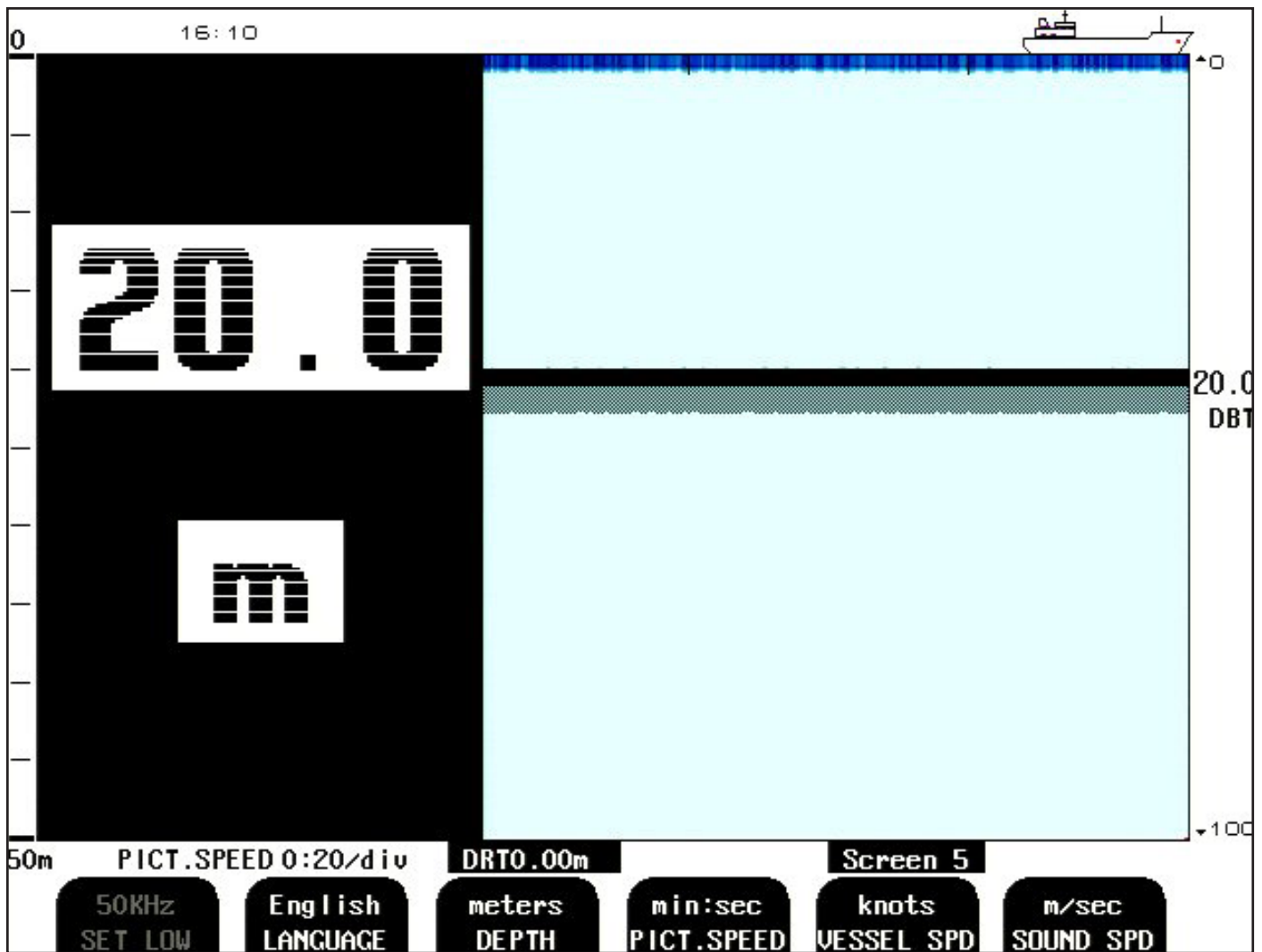

Fig. 2.6. Screen 5, Language and units of measure setup.

This screen shows the main graphic echo gram. Left hand digital indication may be enabled from screen 2.

Soft key	Name	Range/value	Default value	Description
1	SET LOW	10 - 250 kHz (24, 28, 30, 33, 38 kHz)	38 kHz	Adjust indicated frequency of lower frequency channel. Note. Active only if 38 kHz is selected as transducer frequency on “Fig. 2.3. Screen 2, 2nd Operation screen.” on page 14. Also see “Low frequency indication” on page 51.
2	LANGUAGE	English, French, Spanish, Russian, German, Norwegian	English	Screen language selection.
3	DEPTH	Meters, feet, fathoms, braccias	Meters	Unit of measurement for depth.
4	PICT.SPEED	Min:sec	Min:sec	Unit of measurement for picture speed. (See Note below).
5	VESSEL SPD	Knots, km/h, mi/h	Knots	Unit of measurement for vessel speed.
6	SOUND SPD	m/sec, ft/sec	m/sec	Unit of measurement for sound speed.

Note: If a speed log is connected, on NMEA inut or pulse input, it is possible to select different “PICT. SPEED” units. See [“Language and Units of Measure”](#) on page 51.

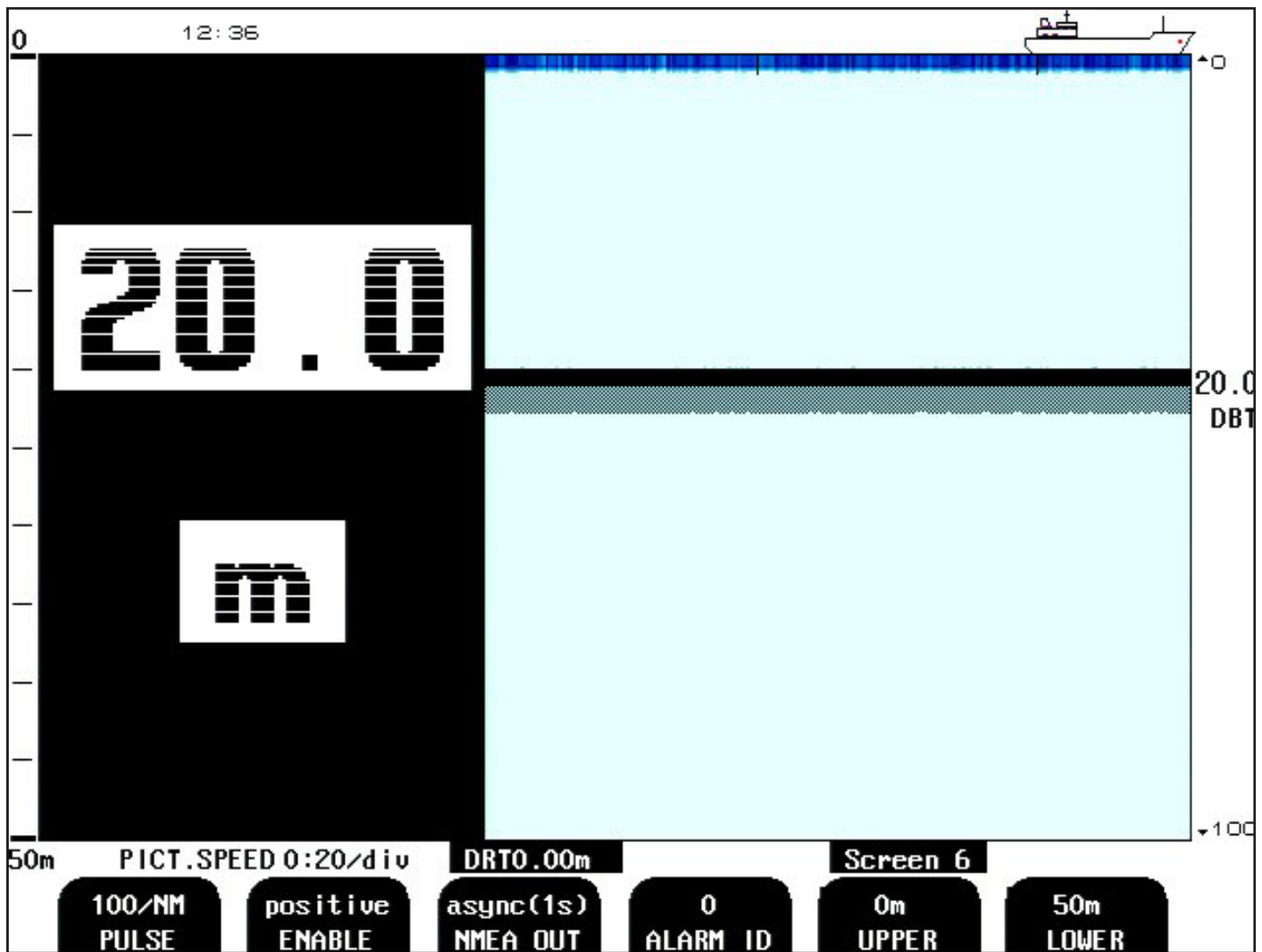

Fig. 2.7. Screen 6, Interface setup screen.

This screen shows the main graphic echo gram. Left hand digital indication may be enabled from screen 2.

Soft key	Name	Range/value	Default value	Description
1	PULSE	100/200/400/20000	100/NM	Speed log input pulse rate. (Pulses per nautical mile).
2	ENABLE (option)	Positive/negative	Positive	Select polarity of external sync signal (remote sounding control option).
3	NMEA OUT	async (1s)/ (sync)hronous	async (1s)	Select between synchronous (with sampling rate) and asynchronous (1s period) NMEA output update.
4	ALARM ID	0 - 999	0	Alarm identifier, used in NMEA alarm sentences to be uniquely recognized by the listener.
5	UPPER	0 - 199 m	0 m	Analogue output shallow water limit = 0 V (4 mA).
6	LOWER	1 - 200 m	50 m	Analogue output deep water limit = 10 V (20 mA).

Note: Soft key 2 controls optional function.

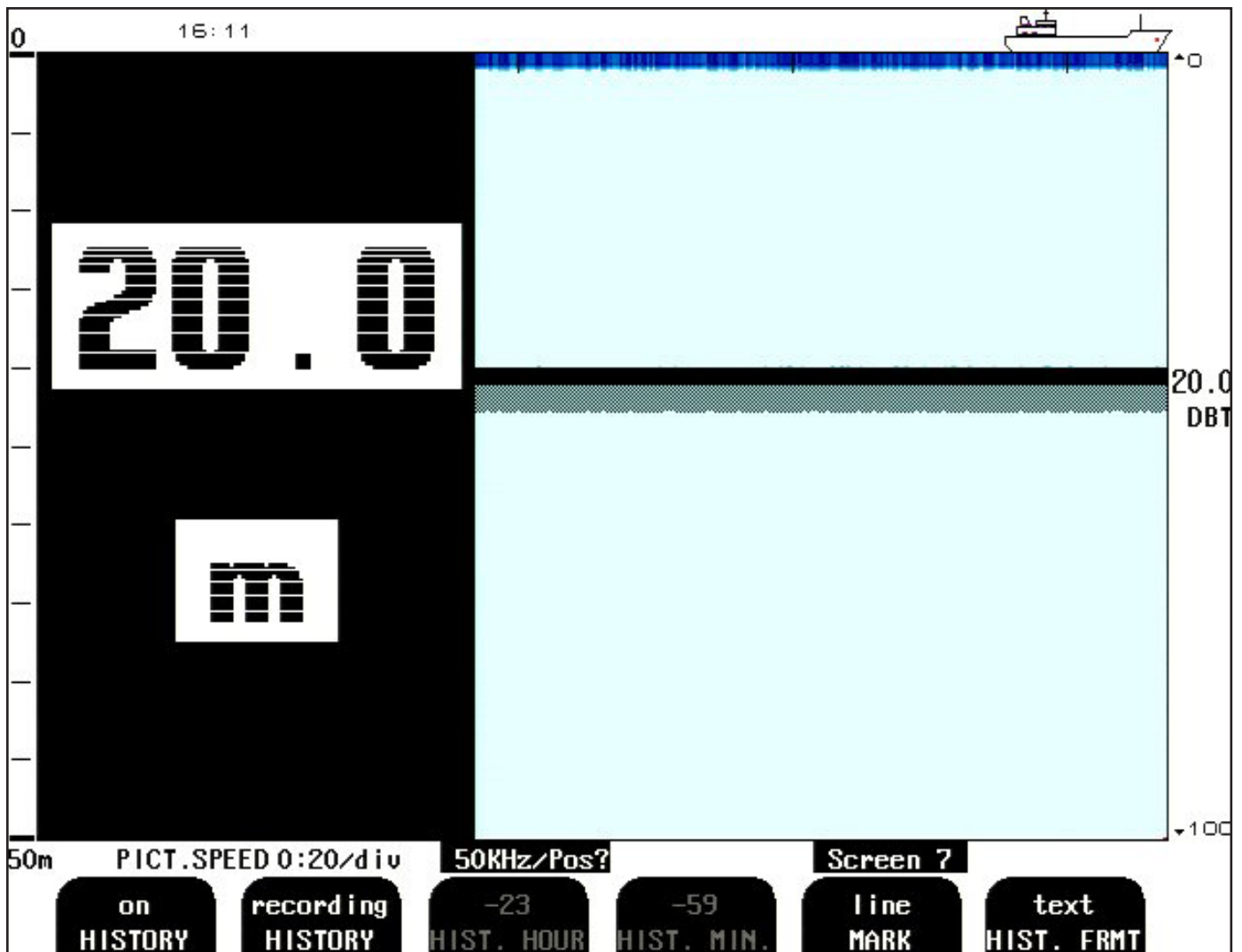

Fig. 2.8. Screen 7, History Memory Control Screen.

This screen shows the main graphic echo gram. Left hand digital indication may be enabled from screen 2.

Soft key	Name	Range/value	Default value	Description
1	HISTORY	On/loop/extended/off	On	On/Off: Start/stop (keep) history recording. Loop: The oldest recordings file will be deleted when the disk is full. Extended: The recordings will stop when the disk is full. (Except for the latest 24 hours, which are always available). For more info, see " History Memory " on page 27.
2	HISTORY	Recording/playback	Recording	Record/playback of history.
3	HIST. HOUR	-23 - 0 hour		History playback spooling, hours. (Note: Active only in playback mode).
4	HIST. MIN	-59 - 0 min		History playback spooling, minutes. (Note: Active only in playback mode).
5	MARK	Line		Print mark line/dump screen.
6	HIST. FRMT	Text/bin	Text	Toggle between text and binary recording format.

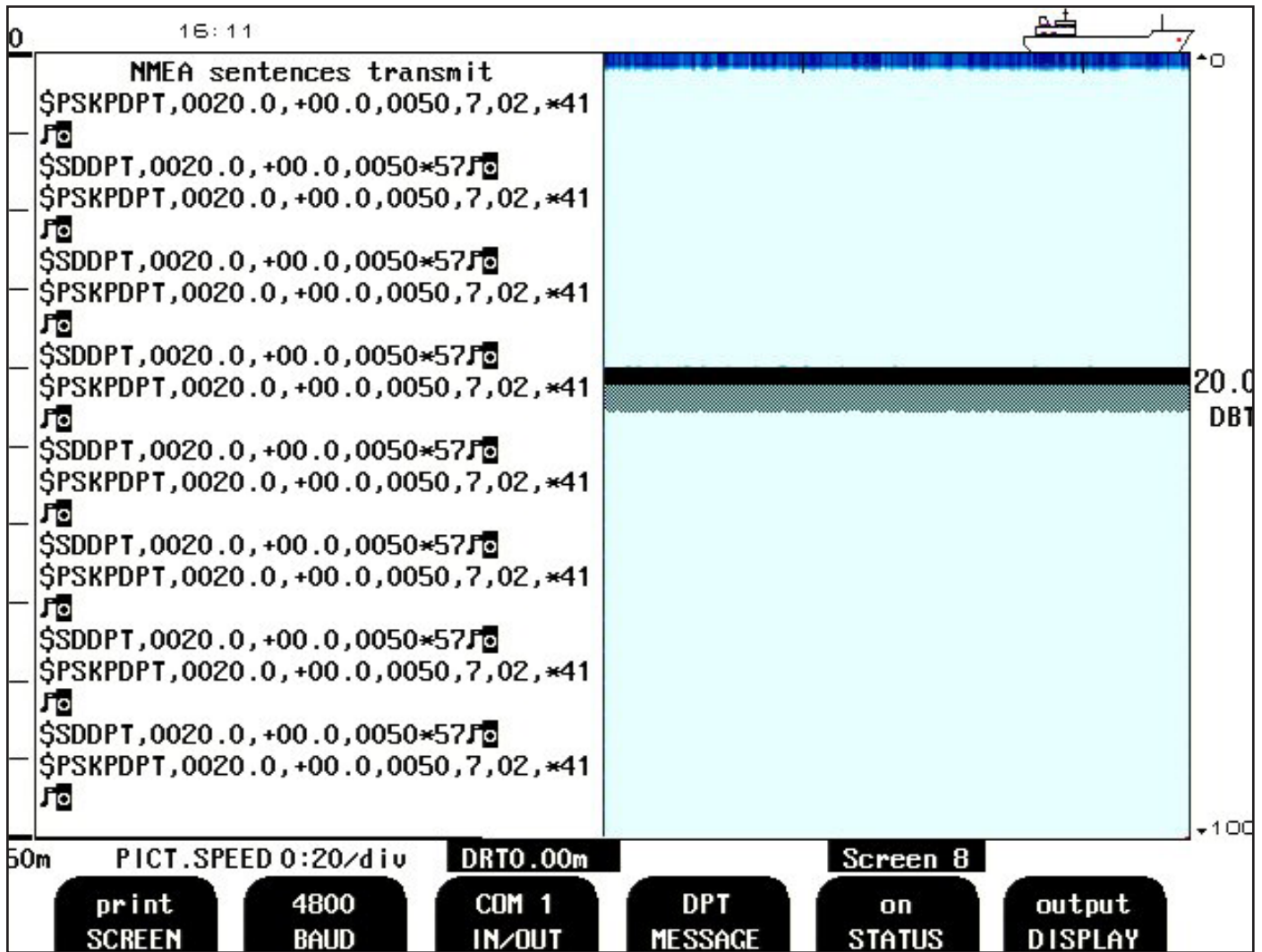

Fig. 2.9. Screen 8, NMEA control screen.

This screen shows list of received or transmitted NMEA messages and half screen echogram.

Soft key	Name	Range/value	Default value	Description
1	SCREEN	Print		Print screen.
2	BAUD	4800/9600	4800	NMEA baud rate selection.
3	IN/OUT	COM 1/COM 2	COM 1	I/O port selection. The text window shows received or transmitted messages on the presently selected channel (COM 1 or COM 2). See “NMEA interface” on page 46.
4	MESSAGE	DPT, DBS, DBT, DBK, PKSKP, CHECK SUM, EN250, EN250 D#, XDR, ALR	DPT: On DBS: Off DBT: Off DBK: Off PKSKP: On CHECK SUM: On EN250: Off EN250 D#: Off XDR: Off ALR: Off	Select if message should be on/off by soft key 5. CHECKSUM, select if PSKPDPT should contain checksum or not by soft key 5. See “NMEA Setup” on page 52.
5	STATUS	On/off		Select if MESSAGE should have “On or “Off” status.
6	DISPLAY	Off/input/output	Input	Selects what kind of information to be displayed. Off: None. Input: Received NMEA messages. Output: Transmitted NMEA messages.

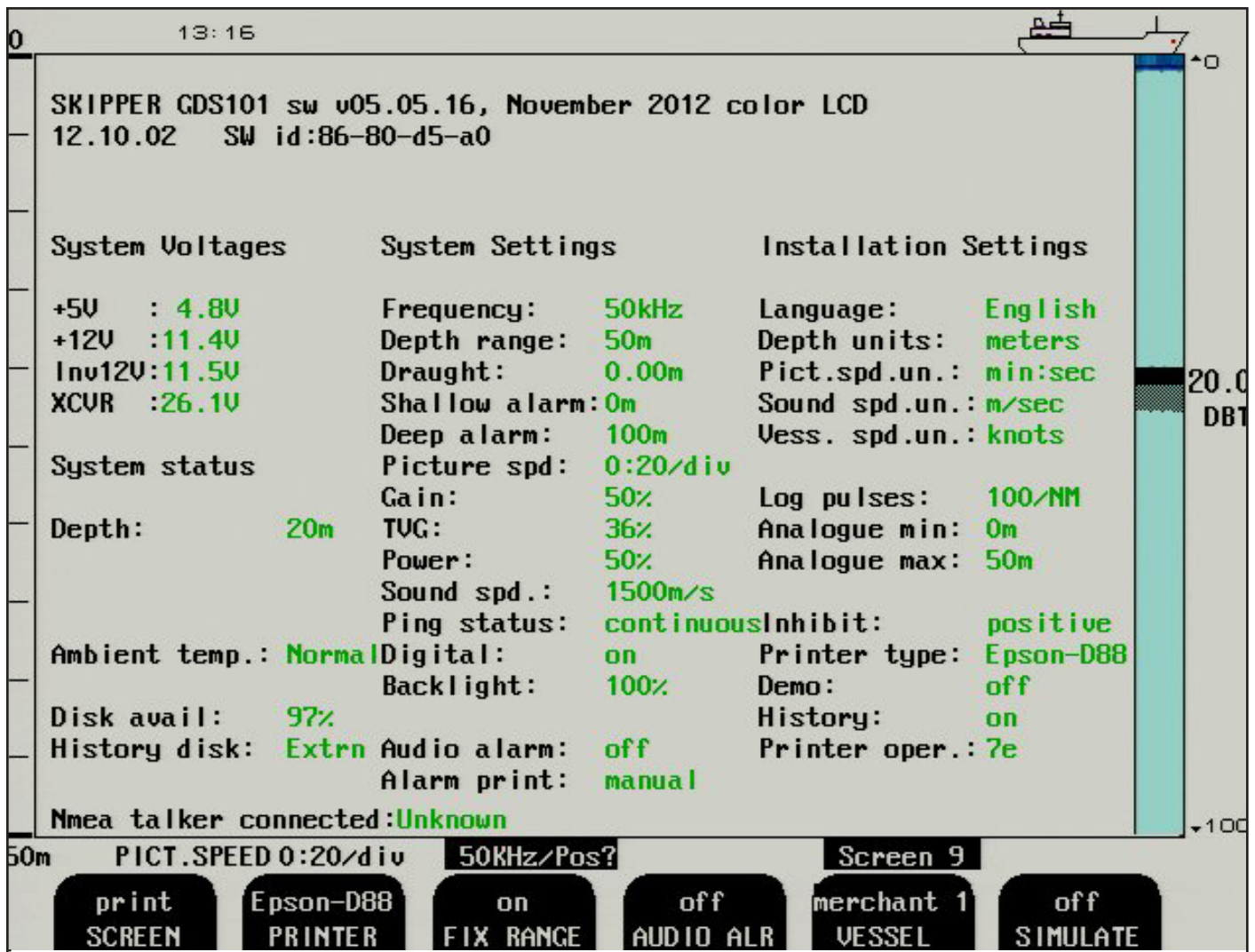

Fig. 2.10. Screen 9, System status screen.

This screen shows a comprehensive list of system settings and parameters

Soft key	Name	Range/value	Default value	Description
1	SCREEN	Print		Print screen.
2	PRINTER	HP DeskJet/Epson-300 (LQ300+) /Epson-D88/Built-in printer.	Epson-D88	Select type of printer that is connected.
3	FIX RANGE	On/off	On	Limit search range to window. FIX RANGE “on” gives better detection in case of noisy signal.
4	AUDIO ALR	On/off	Off	Internal alarm buzzer control.
5	VESSEL	Merchant 1, merchant 2, navy 1, navy 2	Merchant 1	Upper right screen icon selection.
6	SIMULATE	On/off	Off	Built-in simulator control. See “Simulator” on page 28.

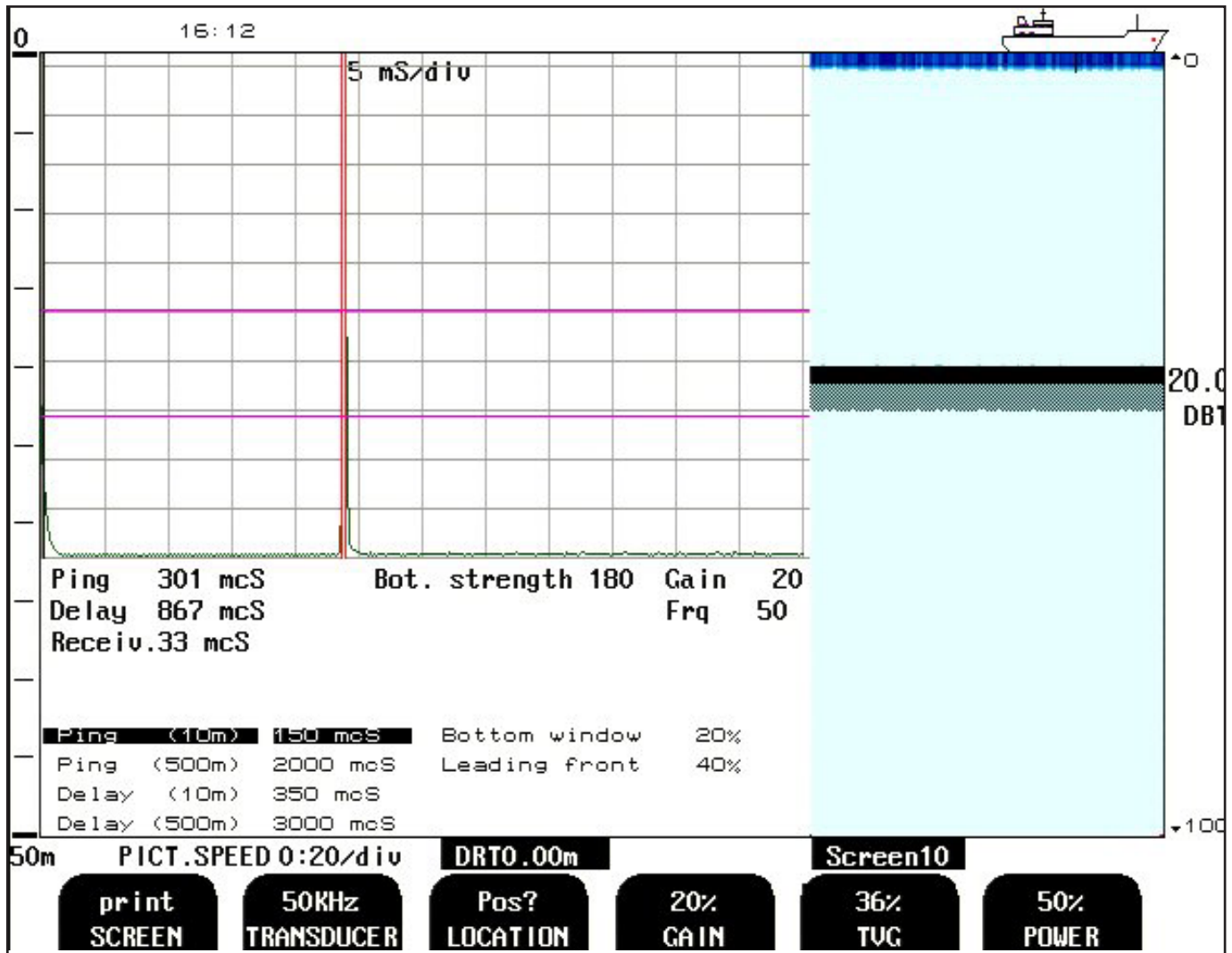

Fig. 2.11. Screen 10, Oscilloscope screen.

This screen shows receiver output versus time and half screen echo-gram.

Soft key	Name	Range/value	Default value	Description
1	SCREEN	Print		Print screen.
2	TRANSDUCER	38, 50, 200 kHz	50 kHz	Transducer selection for soft key 3.
3	LOCATION	Pos? Not installed, FWD, AFT, PORT, STRB, FWD/AFT, PORT/STRB,	Pos?	If “not installed” is selected for one of the frequencies, it will not be available in screen 2, soft key 2. 2 transducers with transducer selector (ENS518): See “ Fig. 9.1 Transducer Selector Connection ” on page 62 and “ Remote Transducer Selector FEEDB (Feedback) ” on page 45.
4	GAIN	0 - 100 %	20 %	Gain adjustment. See “ Gain ” on page 25.
5	TVG	0 - 100 %	36 %	Time Variable Gain adjustment. See “ TVG ” on page 25.
6	POWER	1 - 100 %	50 %	Transmitter power adjustment. See “ Output Power ” on page 25.

Principal Functions

Bottom detection

GDS101 employ a bottom detection algorithm that will try to extract the bottom signal from all kinds of noise and secondary echoes. When GDS101 is tracking the bottom normally, a thick black line is shown, and below that, a ribbon with a hatched pattern. This pattern has two levels of hatching. The darkest represent strong and unambiguous bottom echoes. The lighter hatching represents weaker signals possibly occasional detection misses. If the software can detect no bottom for several pings, the hatched ribbon disappears.

During normal bottom tracking, a digital value is shown by the bottom contour at the right side of the screen. If the software algorithm loses track of the bottom altogether, a warning beep is heard and the black line and hatching band disappears. A warning message: "Lost bottom" is shown in the screen's lower right corner.

Ping to Ping filtering

Part of the bottom detection algorithm is the ping to ping filtering. The next bottom is searched for in a time and strength window based on the strength and timing of the previous bottom echoes. This procedure reduces the probability of tracking schools of fish or secondary echoes as bottom. If no bottom is detected in the calculated window, the window is gradually increased in size until the full time and strength window is used.

Bottom Search Range

The FIX RANGE function in screen 9 is used to control the search range for the bottom detection algorithm. See "[Fig. 2.10. Screen 9, System status screen.](#)" on page 21. When this function is on, bottom is only searched for within the selected display range. When the function is off, bottom is searched for within the entire functional range of the echo sounder.

System (Power) On/Off

During normal daily operation, the system may be switched off from screen 2. See "[Fig. 2.3. Screen 2, 2nd Operation screen.](#)" on page 14. This operation does not disconnect the system from the power supply, but all power consuming components are switched off. The system may be switched on again by pressing any button.

Note: Do not run the sounder for a long time with the transducer in air. The transducer may be damaged.

Remaining disk size diagnostics

The remaining size of the external Compact Flash is indicated at screen 9 (status), "Disk avail". The indication is in percent to the total size. If the external Compact Flash is not installed, the remaining size of the internal Compact Flash is indicated. See "[Fig. 2.10. Screen 9, System status screen.](#)" on page 21.

Fixed Key Functions

Depth Range

The DEPTH RANGE button can be used to set the depth limit between 10 and 1600 m. Standard values available by repeatedly pressing the button are 10, 50, 100, 500 and 1000 m.

Picture Speed

Picture speed may be referred to either time or vessel speed. If no speed log is connected, picture speed will always be referred to time, (“min:sec/div”). Time referenced picture speed may be selected between 20 seconds per division and 5 minutes per division. Vessel speed referenced picture speed may be selected between 0.04 and 5 nautical miles per division. If a speed log is connected, it is possible to select different “PICT.SPEED” units in screen 5. The ping-rate range depends on the depth range, and the fastest ping rate at shallow depths is about 5 pings per second.

Screen Select

The SCREEN SELECT button facilitates selection of one of the 10 screen and soft key layouts. The 3 primary operation screens may be cycled by repeatedly pressing the SCREEN SELECT button. Access to the remaining screens is through encoder operation. The screens are cycled in an endless, bidirectional loop, e.g. turning the encoder counter-clockwise, will activate screen 10 after screen 1. Turning the encoder with no buttons pressed always force screen 1.

Day/Night and back light adjustment (brightness)

Day/Night vision may be selected by pressing this button. These two modes differs by colour presentation, which are optimized for different ambient light conditions.



Soft key Functions

Gain

The received signal gain may be adjusted from 0 to 100 % to allow for optimal echo levels from bottom and other objects. The gain setting affects signals from all depths. See “[Fig. 2.2. Screen 1, Primary Operation screen.](#)” on page 13 and “[Fig. 2.11. Screen 10, Oscilloscope screen.](#)” on page 22.

TVG

Time Variable Gain may be adjusted from 0 to 100 % to allow for detailed echo control from the 0 - 50 m depth range. A low setting will reduce the gain in the area near the surface to suppress noise and unwanted echoes from this area. See “[Fig. 2.2. Screen 1, Primary Operation screen.](#)” on page 13 and “[Fig. 2.11. Screen 10, Oscilloscope screen.](#)” on page 22.

Digital indication

On the operation screens, two sizes of large digital depth indicators may be selected from “[Fig. 2.3. Screen 2, 2nd Operation screen.](#)” on page 14.

1. “Small” digits.
2. “Large” digits.

Frequency

The frequency selector toggles among 38*, 50 and 200 kHz. See “[Fig. 2.3. Screen 2, 2nd Operation screen.](#)” on page 14. * Some units may have been adjusted to other frequencies.

Output Power

Power may be adjusted from 1 to 100 % in case of difficult shallow water conditions. Too high power in such cases will possibly saturate the receiver or cause detection of unwanted secondary bottom or surface echoes. See “[Fig. 2.4. Screen 3, 3rd Operation screen.](#)” on page 15 and “[Fig. 2.10. Screen 9, System status screen.](#)” on page 21. **Note:** Power capability is transducer dependant.

Draught

Draught is used to correct the Depth Below Transducer (DBT) to Depth Below Keel (DBK) or to Depth Below Surface (DBS). This is used when the transducer is not at same position as the lower part of the keel/bottom, or if ship want to know the real water depth from surface. Draught may be compensated to allow real depth from surface to be shown on the screen and printout. Negative draught values may be entered to compensate for transducers fitted above the keel. This setting also affects the NMEA transmitted values. Draught value is indicated on the lower part of the screen by a flashing/alternating number. See “[Fig. 2.4. Screen 3, 3rd Operation screen.](#)” on page 15. In addition, the floating depth on the right side of the screen now also says DBS, DBT or DBK depending on the draught value.

Note: Be aware that if you have two transducers with the same frequency and use the ENS518 transducer selector, the draught setting value will apply for both transducers.

Draught setting	Right side additional screen tekst
Draught = 0 (Default)	DBT
Draught > 0	DBS
Draught < 0	DBK

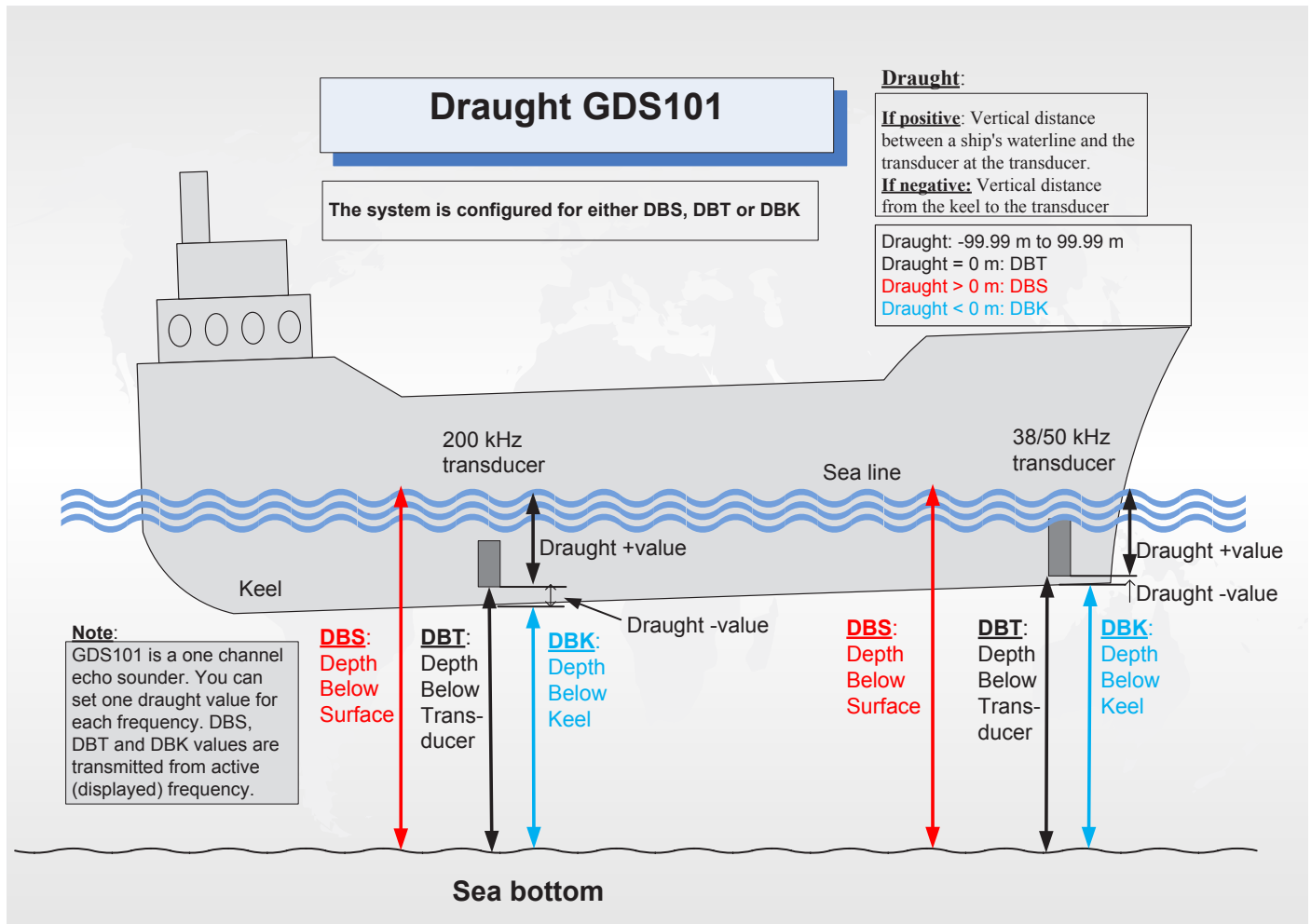

External Printer Operation

The optional external printer is started and stopped by the PRINT button in screen 1 and 2. The printer may be used for continuous printing over a period of time or the current screen contents may be dumped to the printer for reference if something interesting is observed.

- The PRINT button switches continuous printing on and off.
- The MARK button(s) will write a line mark on the paper if it is pressed whenever the printer is running.
- If the MARK button is pressed when the printer is online, this will initiate a screen dump of the present screen contents. If printer is switched off, or not connected, the PRINT button is “dimmed”.

Alarm Settings

Water depth alarm settings are performed from screen 1. Alarm limits are referred to the indicated depth. The local alarm buzzer may be disabled from screen 9, but the external alarm relay will always operate. The only way to disable the alarms completely, is to reduce the shallow water alarm to zero depth and increase the deep water alarm to maximum range. An active shallow water alarm limit must be less than an active deep water alarm limit. Alarm limits are enforced with hysteresis. A depth alarm may automatically start the optional printer, if this function is enabled on screen 4.

Alarm acknowledgement

When any alarm is activated, the alarm may be acknowledged by pressing any button. Alarm relay and audio alarm may be acknowledged by sending the “ACK” NMEA message from an alarm handling system, or by operating a remote button that shorts the KEYB+ and KEYB- lines on the terminal board, (KEYB+ = J100 pin 10, KEYB- = J100 pin 11.) See [“Fig. 4.11. Alarm interconnections” on page 48.](#)

Alarm ID

Alarm identifier, used in NMEA alarm sentences to be recognized by the listener and allowing the system to uniquely identify each alarm type.

Audio warning

An internal audio alarm buzzer may be switched on (default off) if an external alarm buzzer is not connected. See [“Fig. 2.10. Screen 9, System status screen.” on page 21.](#)

Clock and Calendar Settings

Manual clock and calendar adjustments are carried out in screen 4. If a satellite navigator giving UTC messages is connected to the NMEA input, the clock and calendar will be automatically updated and manual adjustment is not required. See [“Fig. 2.5. Screen 4, Calendar and clock setting.” on page 16.](#)

History Memory

GDS101 has a 24 hour history memory. Depth, time and all available navigation data are stored continuously, so that the last 24 hours of information is always available. The history memory is controlled from screen 7. See [“Fig. 2.8. Screen 7, History Memory Control Screen.” on page 19.](#) The normal history modes are “on” and “recording”. New depth information is continuously stored in the memory while the oldest samples are discarded. Only depth information is stored along with time and whatever navigational information is available in the GDS101 (position, speed, heading). By switching HISTORY off, the stored 24 hours will be kept in the memory and no new samples will be recorded. As a warning that the memory is not recording, “HISTORY off” is flashing at the bottom of the screen. History modes “on” and “playback” will start playing the contents of the history memory on the screen and on the optional printer, if it is running. As a warning that the displayed bottom contour is from the memory and not real time, “HISTORY” is flashing at the bottom of the screen. The HIST HOURS and HIST MINUTES buttons used with the encoder, will enable positioning within the 24 hour memory to observe the desired part of the time frame during playback.

An option is available for logging of depth, settings, and some external data if applied. To activate this function, the HISTORY button must be on one of the following two settings:

Loop: In case of “loop” mode the oldest recordings file will be deleted, when the disk is full.

Extended: In case of “extended” mode, the recordings will stop, when the disk is full.

Note: If installed, (default and recommended) history data will be recorded on the external Compact Flash. On screen 9 (System status screen), this is indicated as “History disk: **Extrn**”. If the external Compact Flash is **not** installed, the history data will be recorded on the “program” Compact Flash located on the rear side of the CPU board. On screen 9 (System status screen), this is indicates as “History disk: **Sys**”. See [“Fig. 2.10. Screen 9, System status screen.” on page 21.](#)

Note: Always turn off the unit with the switch on the Terminal board when removing/replacing the CF disk.

TXT/BIN: A new file will be created every hour. The filename format is YYMMDDHH.[ext], where YY is current year, MM – current month, DD – current date and HH – current hour. The extension depends on the recordings type. In case of text recordings, the extension is “txt”, in case of binary format – “bin”. If the file, corresponding to the current date/time already exists, the new history will be appended; otherwise the new file will be created.

The GDS logging function, logs all changes in results or settings when the value changes. The files will be very small if the vessel sails without external inputs. However assuming all parameters are changed for every ping (impossible) and GPS is also logged, data in .txt format will give a minimum of 177 days data per GB disk space. In reality a GB can easily give a year of data.

The standard disk is 128 MB giving a minimum of 20 days, in practice 2 months. The system can be made to loop or log until the disk is full. The amount of disk left is shown on the status screen. Bin files store the same data in binary format and will be smaller. New files are started every hour, and named by the date and time. Each new file will have the full settings in the first lines.

Simulator

The GDS101 contains a built in simulator to test the screen and various interface signals. The simulator may be switched on and off on screen 9. When the simulator is operating, “DEMO” is flashing at the bottom of the screen. See [“Fig. 2.10. Screen 9, System status screen.” on page 21.](#)

Status Screen

The status screen, screen 9 shows a list of various system parameters useful for documenting system setup and operating status. The contents of this screen will be valuable information in situations where manufacturer support is required. See [“Fig. 2.10. Screen 9, System status screen.” on page 21.](#)

Oscilloscope Screen

The oscilloscope screen, screen 10 is useful when monitoring transceiver performance. The oscillogram shows the signal returned from the transceiver plotted against time and will enable service personnel to evaluate system performance and facilitate any troubleshooting. See [“Fig. 2.11. Screen 10, Oscilloscope screen.” on page 22.](#)

Nonvolatile Flash Parameter Memory

The system contains internal flash memory to maintain installation and user parameters like language and unit of measurement selection, contrast and backlight settings, etc. These parameters are automatically restored on power up. If the user parameters have never been set, default values are used.

Options

Repeaters/Slaves

Graphic display or digital depth slave repeaters may be connected to the system. Along with the graphic display repeaters, there may also be installed a remote keyboard.

Remote Sounding Control

This option lets the GDS101 being controlled remotely in synchronized (edge), burst (level) or single ping modes. If installed, this option is accessible on screen 3. See [“Fig. 2.4. Screen 3, 3rd Operation screen.” on page 15.](#) (**Note:** Non Wheelmark model).

Auto Range

This option will automatically adjust the depth range to maintain the bottom contour within the middle part of the screen height. If installed, this option is accessible on screen 3. See [“Fig. 2.4. Screen 3, 3rd Operation screen.” on page 15](#). When the optional printer is started, auto range is automatically disabled, and the present depth range is selected as fixed.

Sound Speed Calibration

This option will enable adjustment of the sound speed value used for the depth calculations. The standard value is 1500 m/s, but the user may set values from 1400 to 1550 m/s to accommodate accurate propagation speed in known water conditions. If installed, this option is accessible on screen 3. See [“Fig. 2.4. Screen 3, 3rd Operation screen.” on page 15](#). (**Note:** Non Wheelmark model).

External Printer

Printer for endless paper or ink-jet printer for single sheets may be connected for hardcopy requirements. Ask local representative or manufacturer for specifications. (Contact details on title page).

3. User Maintenance

Transducer Maintenance

The transducers are virtually maintenance free, but occasional cleaning may be necessary depending on sea water conditions.

Operator Unit Maintenance

The operator unit contains no user serviceable parts, and requires no maintenance apart from occasional cleaning of the front panel. Please use a soft cloth and no chemicals except cleaning alcohol.

Note: In normal usage, the system should show satisfactory results with the following settings:

- Gain = 20 %.
- TVG = 36 %.

Always try to return to these settings before continuing.

Please also try a “Master Reset”, see [“Master Reset Procedure” on page 60](#) for more details.

Trouble Shooting

Symptom	Cause	Remedy
Basic System Integrity		
<ul style="list-style-type: none"> • No picture on LCD screen. 	<ol style="list-style-type: none"> 1. No AC or DC power to the system. 2. System is in standby. 3. Too low screen backlight. 4. Defective LCD module or interface. 5. Voltage(s) out of range. 6. System rebooted too quickly. 	<ol style="list-style-type: none"> 1. Check switches and fuses on the terminal board inside the GDS101 cabinet. 2. Press any button on panel. 3. Increase backlight setting, change to day vision. 4. Replace module or backlight inverter PCB. 5. Replace terminal PCB. 6. Turn off power switch(es) - wait a few sec, restart.
<ul style="list-style-type: none"> • Picture is difficult to read. 	<ol style="list-style-type: none"> 1. Backlight is too weak. 2. Night vision is on during day time. 	<ol style="list-style-type: none"> 1. Increase backlight setting. 2. Increase backlight setting, or change to day vision.
<ul style="list-style-type: none"> • Display backlight malfunctions. • Display picture is hardly visible. 	<ol style="list-style-type: none"> 1. Defective backlight tubes. 2. Defective keyboard. 3. Defective backlight inverter. 	<ol style="list-style-type: none"> 1. Replace tube assembly. 2. Replace keyboard PCB. 3. Replace backlight inverter PCB.
<ul style="list-style-type: none"> • Rotary encoder malfunctions. 	<ol style="list-style-type: none"> 1. Defective encoder or interface. 2. Cabling error. 	<ol style="list-style-type: none"> 1. Replace keyboard PCB or terminal PCB. 2. Check cabling to IO board J101 at both ends. (No cable on J103).
<ul style="list-style-type: none"> • Panel buttons malfunctions. 	<ol style="list-style-type: none"> 1. Defective buttons or interface. 2. One button stuck. 	<ol style="list-style-type: none"> 1. Replace keyboard PCB or terminal PCB. 2. Check key switches or replace keyboard PCB.

Typical Status Screen (9) Contents

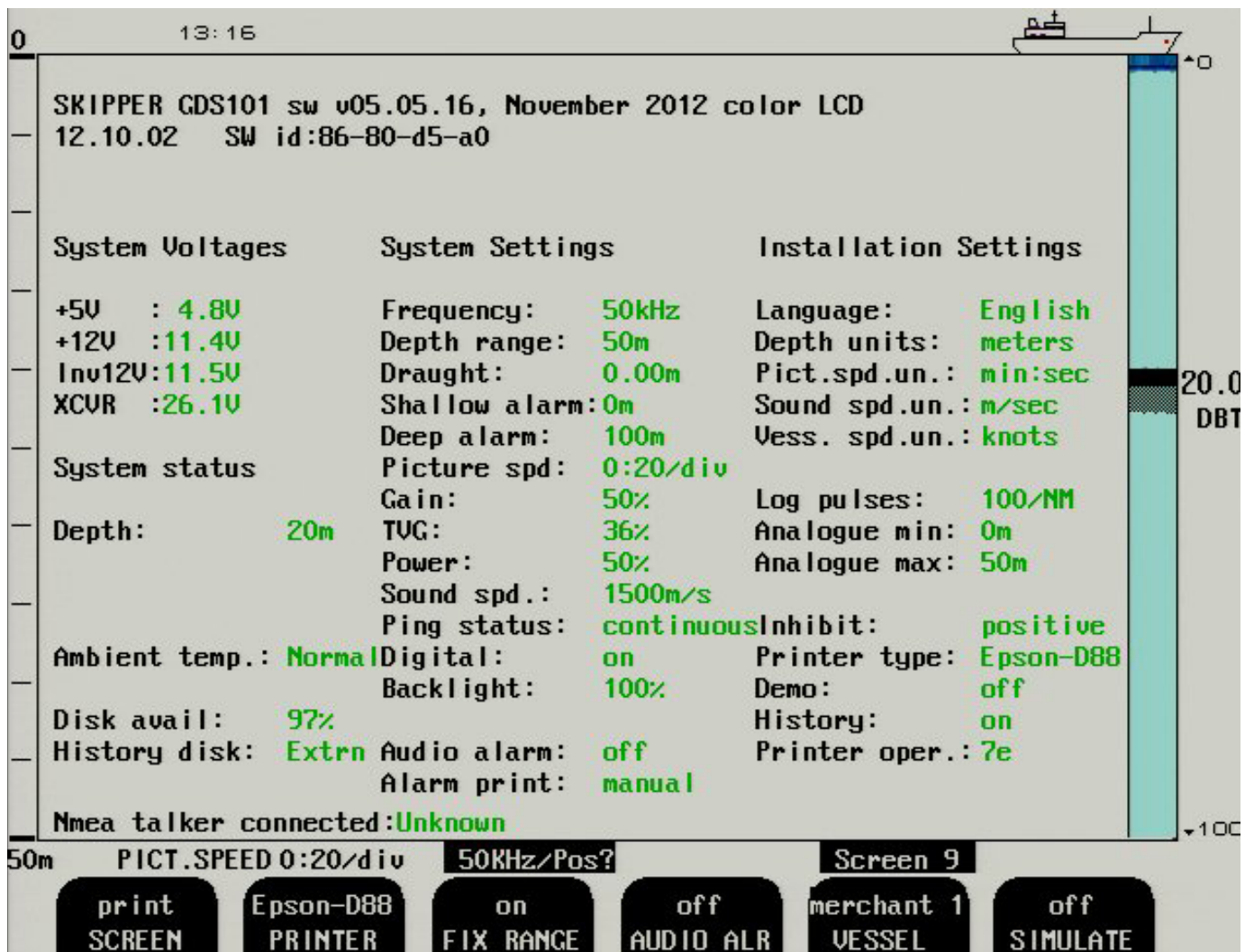

The status screen (9) contains information that will facilitate analysis and correction of several problems. A printout or picture of the status and oscilloscope screens should be sent by fax/E-mail with any report about functional disturbance. This will greatly facilitate remote failure analysis.

If it is at all possible to cycle through the screens and observe this information, several assumptions may be made regarding operation of the GDS101 system. Although some of the subsystems necessary for this basic system operation may still suffer from minor or intermittent operation disorders, the fact that it is possible to select and observe this screen, indicates correct operation of the following GDS101 subsystems:

- The CPU board is operating.
- The keyboard is working.
- The keyboard interface part of the I/O board is working.
- The power supplies on the terminal board are basically working.

Note: XCVR is linked to Power max (100 % = 42 - 48 V, 50 % = 23 - 27 V etc.). If the numbers are different, adjust your unit to the correct values and check if fault still occurs.

Symptom	Cause	Remedy
Status screen diagnosis		
Main voltages out of range <ul style="list-style-type: none"> • + 5 V: \triangleleft 4.50 - 5.00 V • + 12 V: \triangleleft 11.00 - 12.00 V • Inv 12 V: \triangleleft 11.00 - 12.00 V 	<ul style="list-style-type: none"> • Defective power supply. • Power supply overload. 	<ul style="list-style-type: none"> • Replace terminal board. • +5 V: Computer or I/O board problem. • +12 V: Transceiver problem.
<ul style="list-style-type: none"> • Lost bottom, transceiver (XCVR) voltage low. 	<ul style="list-style-type: none"> • Power setting too low. 	<ul style="list-style-type: none"> • Increase power setting.
<ul style="list-style-type: none"> • Lost bottom, transceiver (XCVR) voltage <10 V when power is 50 % or 100 %. 	<ul style="list-style-type: none"> • Defective I/O card. 	<ul style="list-style-type: none"> • Replace I/O card, possibly terminal board.
<ul style="list-style-type: none"> • System reboots intermittently. 	<ul style="list-style-type: none"> • Bus cable or motherboard error. 	<ul style="list-style-type: none"> • Temporary fix maybe to clean and reseal the motherboard connectors. • Replace cable and/or card.

The other information on the status screen is a collection of information which may be observed and manipulated with the various screen soft key selections. As a reference, it will often be more convenient to observe the various settings together on this screen than to cycle from screen to screen to check on the soft key texts.

Typical Oscilloscope Screen (10) Contents

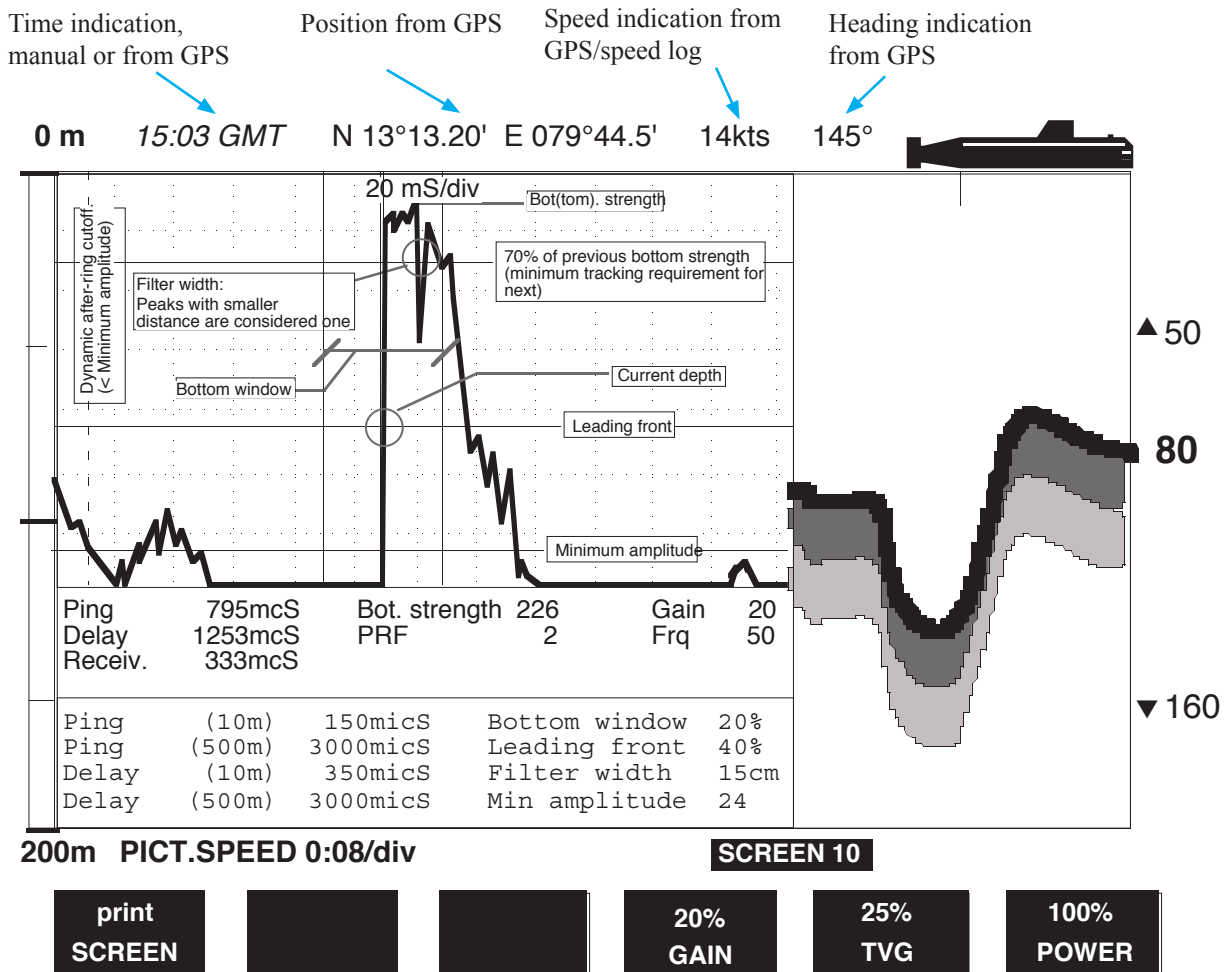

This oscilloscope screen 10 shows a typical oscillogram of a bottom echo (the tall peak in the centre of the diagram) and a weaker fish echo to the left of it. The horizontal axis represent time for the sound to travel down and back from an object. The vessel is located at the left edge of the grid, and the right edge represent the depth range. The vertical axis represent the magnitude of the echo signal received.

The length of the ping and the delay between pings, will adjust between preset limits (ping (10 m) and ping (500 m)). The actual length of these extremes are shown here.

Symptom	Cause	Remedy
Basic Functionality		
<ul style="list-style-type: none"> No bottom detection or bottom contour. 	<ul style="list-style-type: none"> Too low gain setting. Too low TVG setting. Too low power setting. Wrong frequency selection. 	<ul style="list-style-type: none"> Adjust settings. Select correct frequency.
<ul style="list-style-type: none"> Bottom tracking is intermittent or erroneous. 	<ul style="list-style-type: none"> Marginal gain, TVG or power settings. Weather conditions. Transducer installation faulty. 	<ul style="list-style-type: none"> Adjust settings. Try adjust gain, TVG or power settings. Check transducer wiring, receiver LED LD300 on IO board, or oscilloscope screen.
<ul style="list-style-type: none"> Bottom tracking is masked by high noise levels. 	<ul style="list-style-type: none"> Too high gain setting. Too high TVG setting. Too high power setting. 	<ul style="list-style-type: none"> Adjust settings.
Symptom		
Cause		
Remedy		
NMEA Interface etc.		
<ul style="list-style-type: none"> NMEA input signals are not listed in the NMEA screen. 	<ul style="list-style-type: none"> Wrong polarity input signals. 	<ul style="list-style-type: none"> Swap NMEA 0183 input wires.
<ul style="list-style-type: none"> NMEA input signals are listed in the NMEA screen, but not accepted by the GDS101. 	<ul style="list-style-type: none"> GDS101 initialization. Irregular message mnemonic. 	<ul style="list-style-type: none"> Cycle GDS101 power after NMEA connection is established.
<ul style="list-style-type: none"> NMEA signals are not accepted by the remote system. 	<ul style="list-style-type: none"> Remote (listener) setup. 	<ul style="list-style-type: none"> Verify correct remote (listener) setup.
<ul style="list-style-type: none"> Analogue output malfunctions. 	<ul style="list-style-type: none"> Incorrect range setting. 	<ul style="list-style-type: none"> Verify upper and lower limits in screen 6.
<ul style="list-style-type: none"> Pulse output malfunctions. 	<ul style="list-style-type: none"> Incorrect pulse frequency setting. 	<ul style="list-style-type: none"> Verify pulse settings in screen 6.
<ul style="list-style-type: none"> External control inputs malfunction, inhibit/external printer control. 	<ul style="list-style-type: none"> Incorrect polarity or function settings. 	<ul style="list-style-type: none"> Verify settings in screen 6.

4. Installation

Standard System Supply

A basic GDS101 system consists of the following units:
(See [“Fig. 4.1. Basic System Configuration.”](#) on page 36).

- Operator unit with installation material.
- Transducer junction box(es). See [“Fig. 4.2. Transducer Junction Box.”](#) on page 37.
- Approved transducer steel tank(s) or sea valve(s).
- Transducer(s) and mounting.
- Operation and installation manual.

Transducer Installation

Location

- A transducer should be installed in an area securing optimal measurement free from noise and aeration.
- Transducers are normally installed in the noise free area in the foreship (see **A** on fig.)

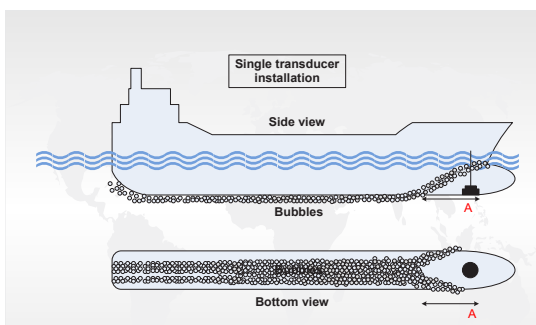

Optimal system operation is achieved by fitting the transducer as deep as possible on the hull. The transmitting surface of the transducer must be installed horizontally.

Do not mount transducers close to the propeller or aft of other hull installations (outlets, vents or other protruding details). It is necessary to select a part of the hull that is submerged under all load and speed conditions, and to avoid positions where air is trapped in heavy weather.

If a flat, horizontal section is not available for transducer fitting, the shipyard must construct a suitable bed.

Larger vessels are often fitted with two transducers, one fore and one aft (see fig.)

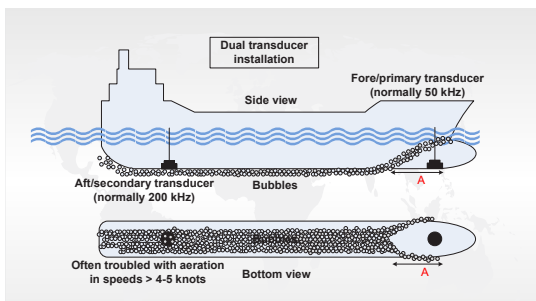

The fore transducer is the primary transducer, (normally 50 kHz). The aft transducer is a secondary transducer, (normally 200 kHz).

The aft transducer will be troubled with aeration and noise and will not operate in speed >4-5 knots. It is used to measure aft depth in shallow water.

Installation Details

Refer to SKIPPER's installation procedures in the appendix and on our web site www.skipper.no regarding information about sea valve, tank installation, welding, cable glands etc.

Note:

- Protect the active element of the transducer and **do not paint the surface**.
- Transmission in **the air must be avoided!** This may cause mechanical damage of the element.

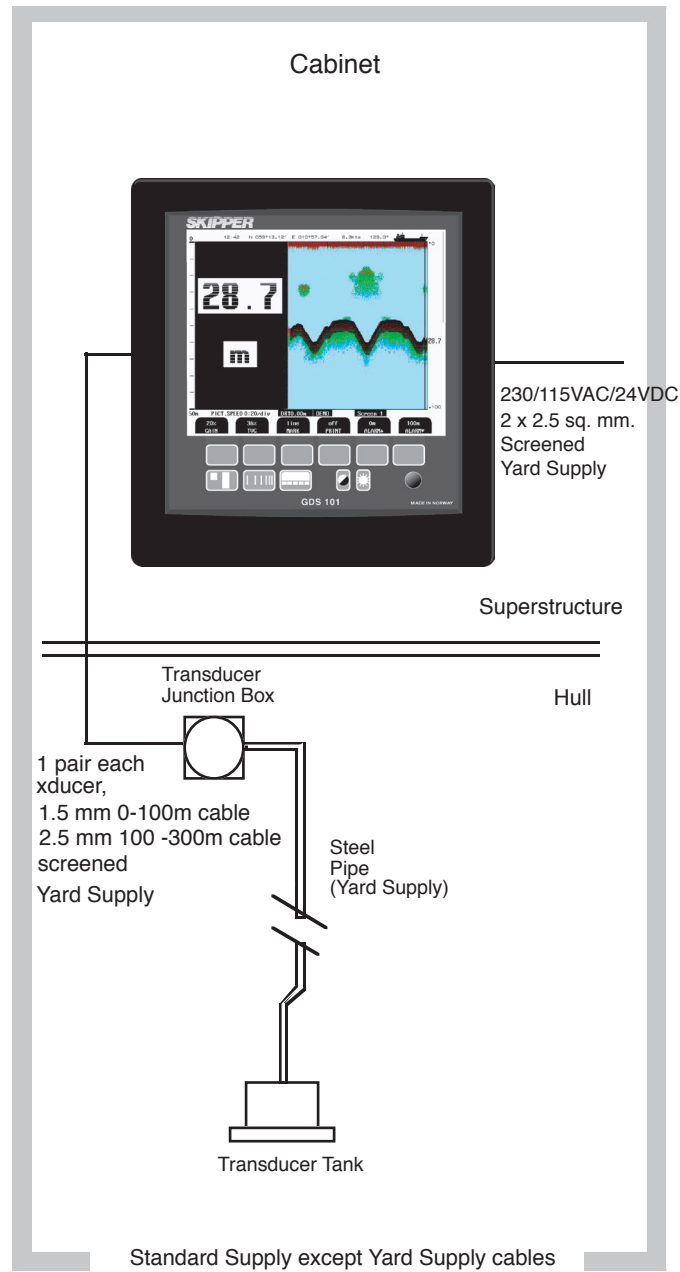

Fig. 4.1. Basic System Configuration.

Transducer Junction Box

The standard cable fitted on the transducer is 25 m or 40 m and may be shortened. The junction box is used to interconnect the transducers fixed cable to a yard supply extension cable if the total required cable length is longer than the standard cable. In tank installations, it is required to run the standard cable in a steel protecting pipe from the tank to the highest water level. Special requirements apply in areas with explosive conditions. The junction box must always be mounted outside such areas.

Interconnect the transducer pair and its screen in the junction box, **but do not ground the screen here.**

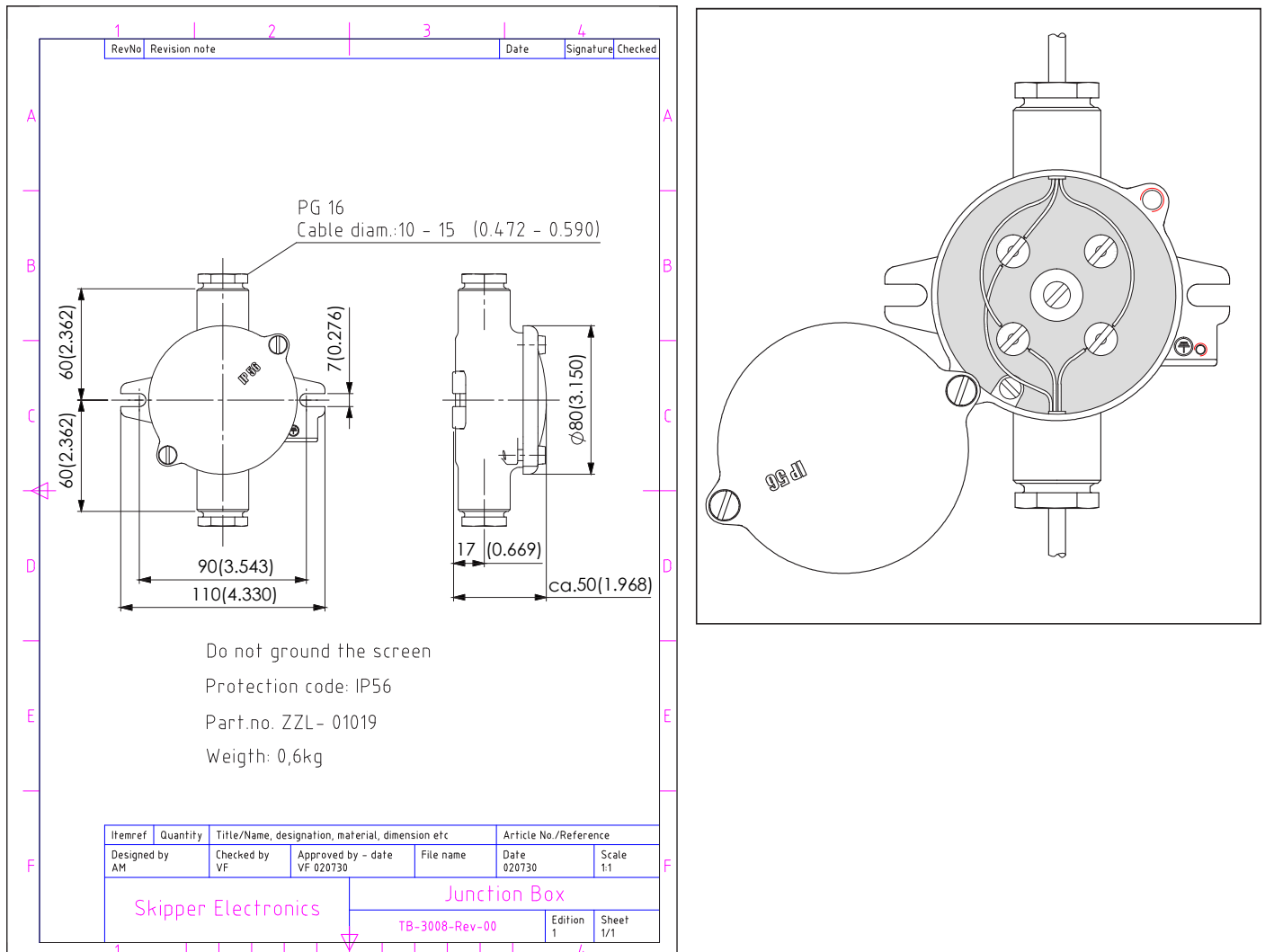

Fig. 4.2. Transducer Junction Box.

Operator Unit Installation

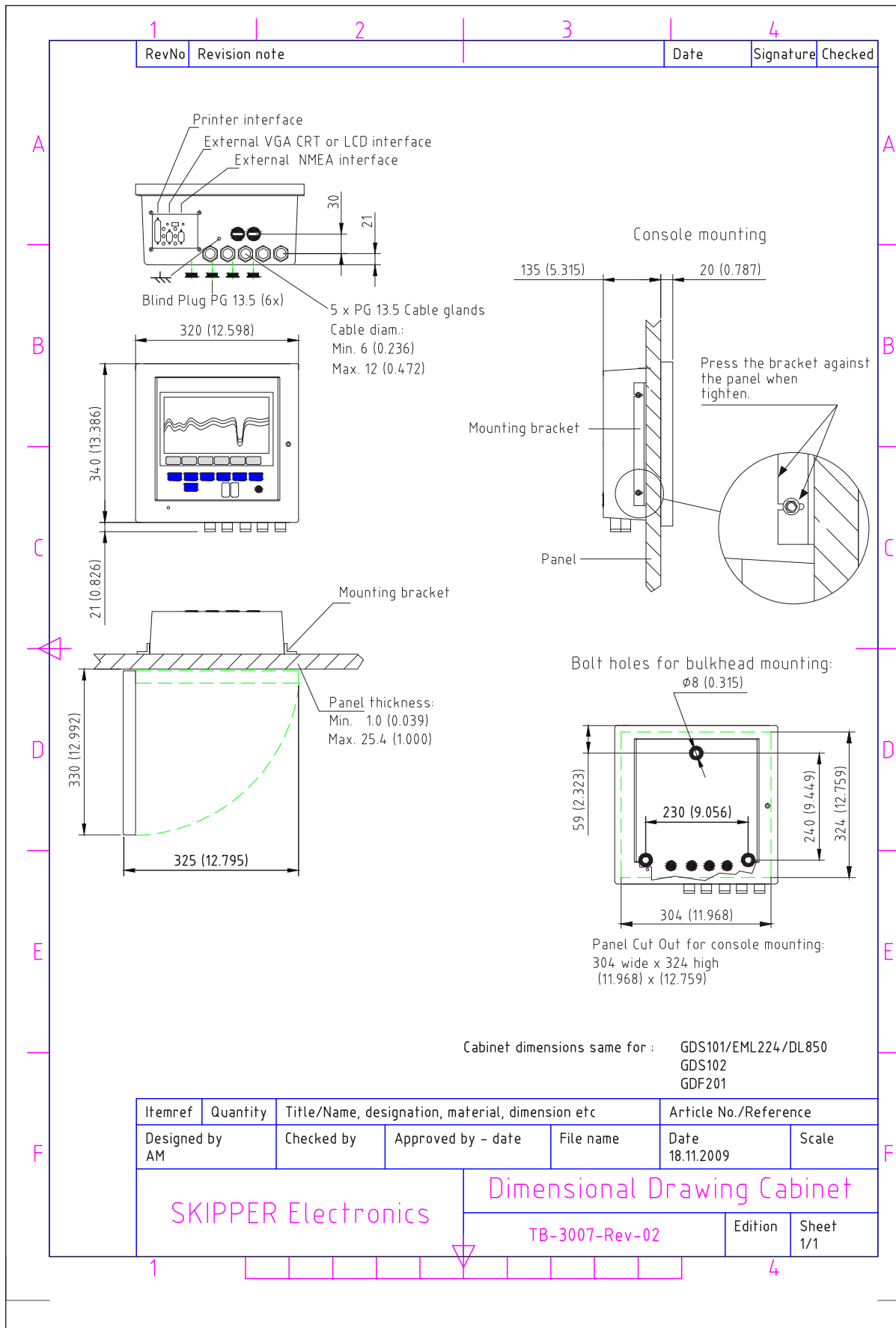

Fig. 4.3. Operator Unit.

History memory battery, JP101



NOTE:

JP101 is marked J103 on some boards.

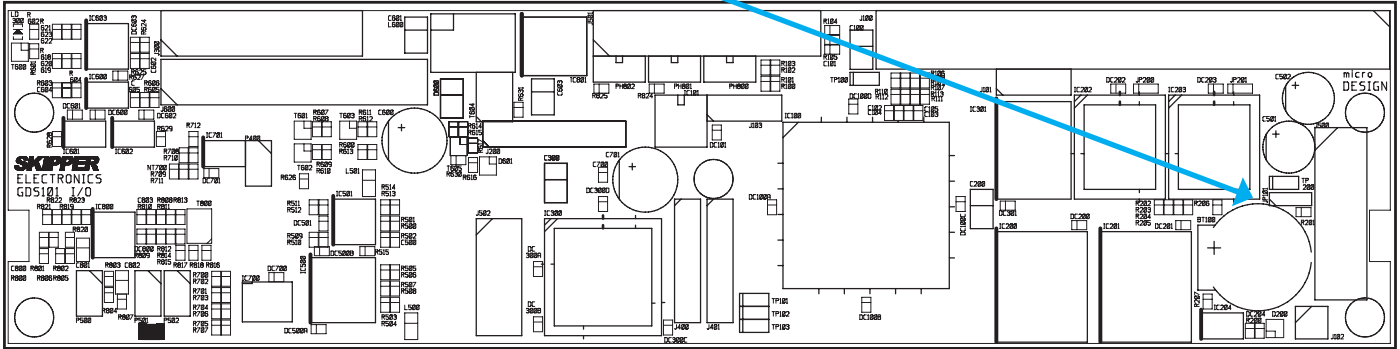
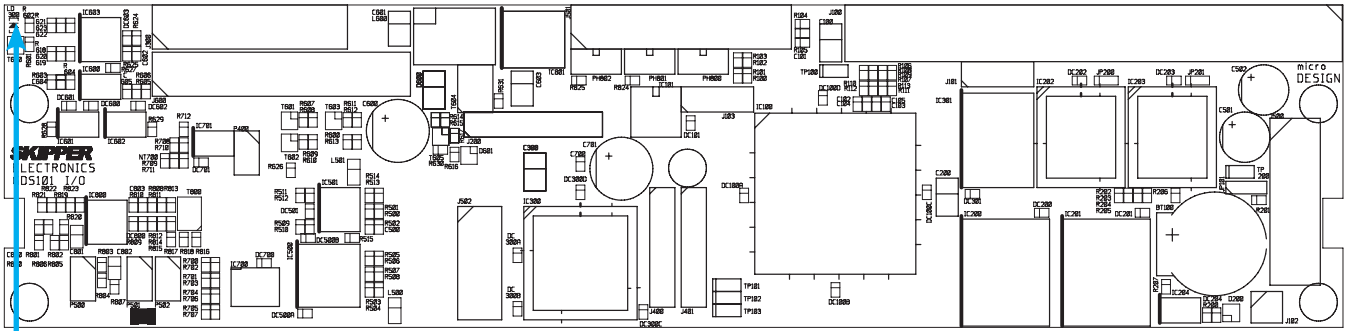
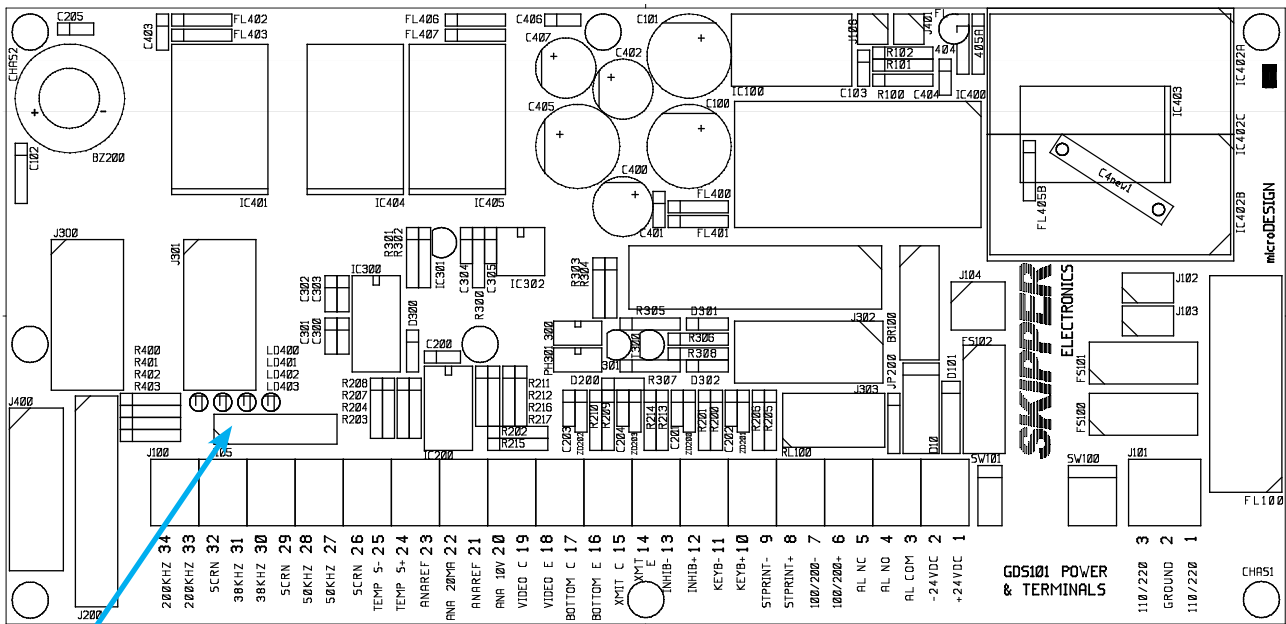

Fig. 4.5. History Memory Battery Jumper, I/O Board.

Note: In the latest GDS101 versions, (starting from Sw 5.05.02) CMOS memory for storing “history” is not used. Here all values are stored on the Compact Flash. The jumper JP101 and battery BT100 is present only for backward compatibility.



LD300 on IO board



LD400 - LD403 on terminal board

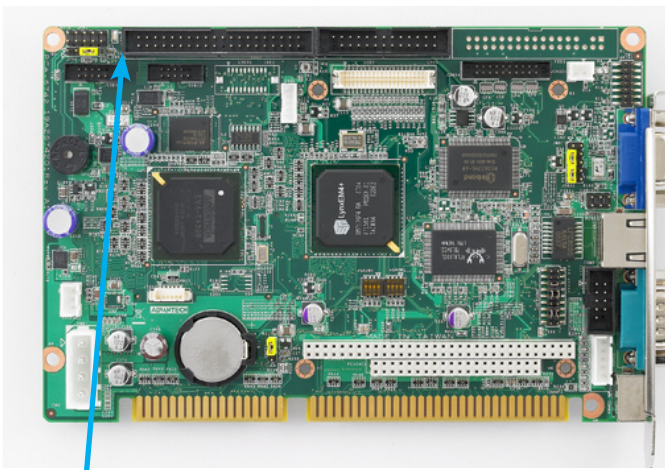

LED1 on CPU board

Power indication and function LEDs		
Terminal board		
LED	Indicating	Colour
LD400	+ 5 V	Green
LD401	+ 12 V	Yellow
LD402	+ 12 V	Yellow
LD403	+ 48 V	Yellow
I/O board		
LED	Indicating	Colour
LD300	Transceiver operation	Green
CPU board		
LED	Indicating	Colour
LED1	CPU Power	Green

Fig. 4.6 Function LEDs, Terminal, I/O and CPU Boards.

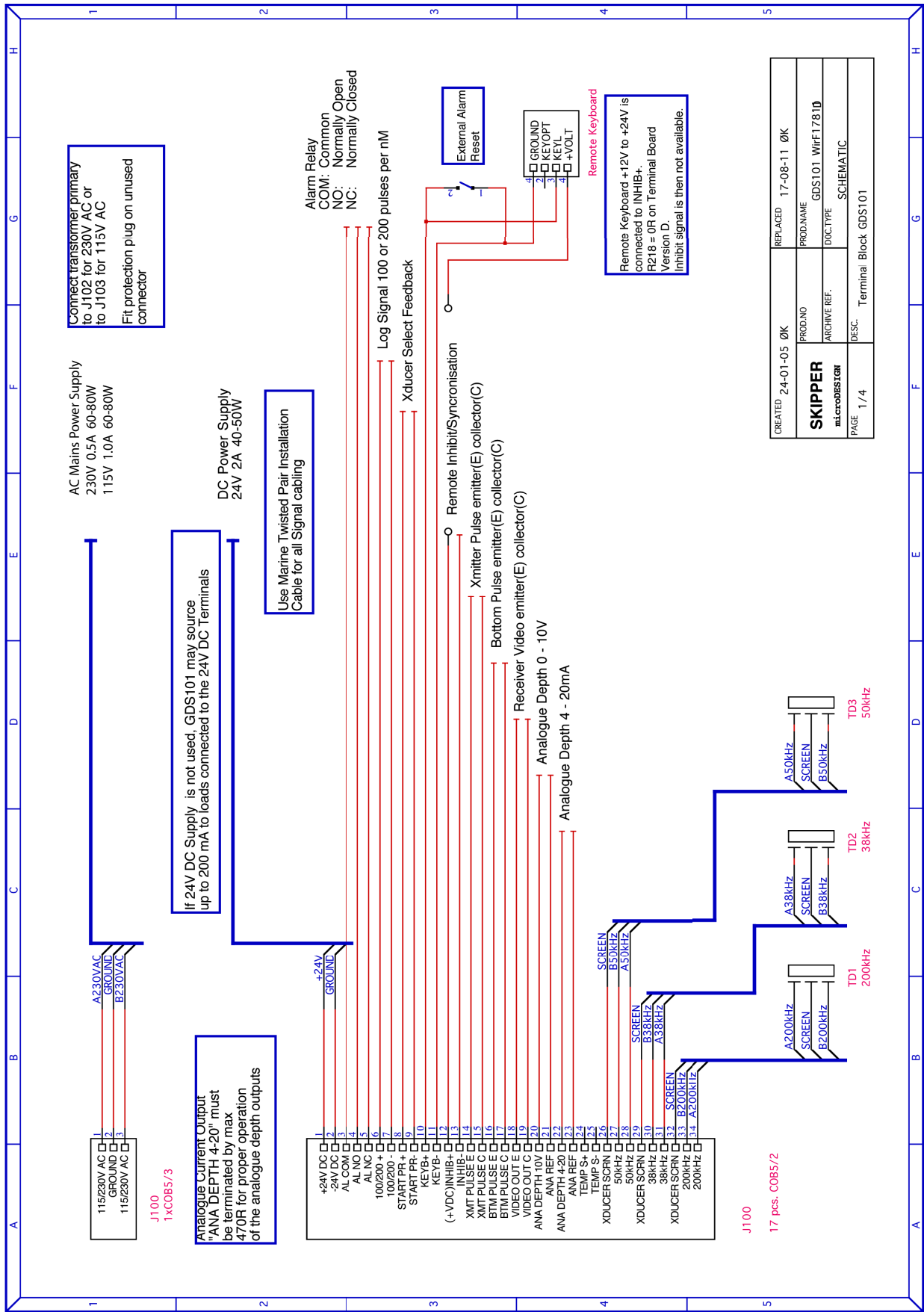

CREATED	24-01-05	ØK	REPLACED	17-08-11	ØK
PROD.NO	SKIPPER				
ARCHIVE REF.	mMicroBESTGEN				
DOC.TYPE	GDS101 WHF1781D				
DESC.	SCHEMATIC				
PAGE	1 / 4				
Terminal Block GDS101					

Fig. 4.7. Main Wiring Diagram.

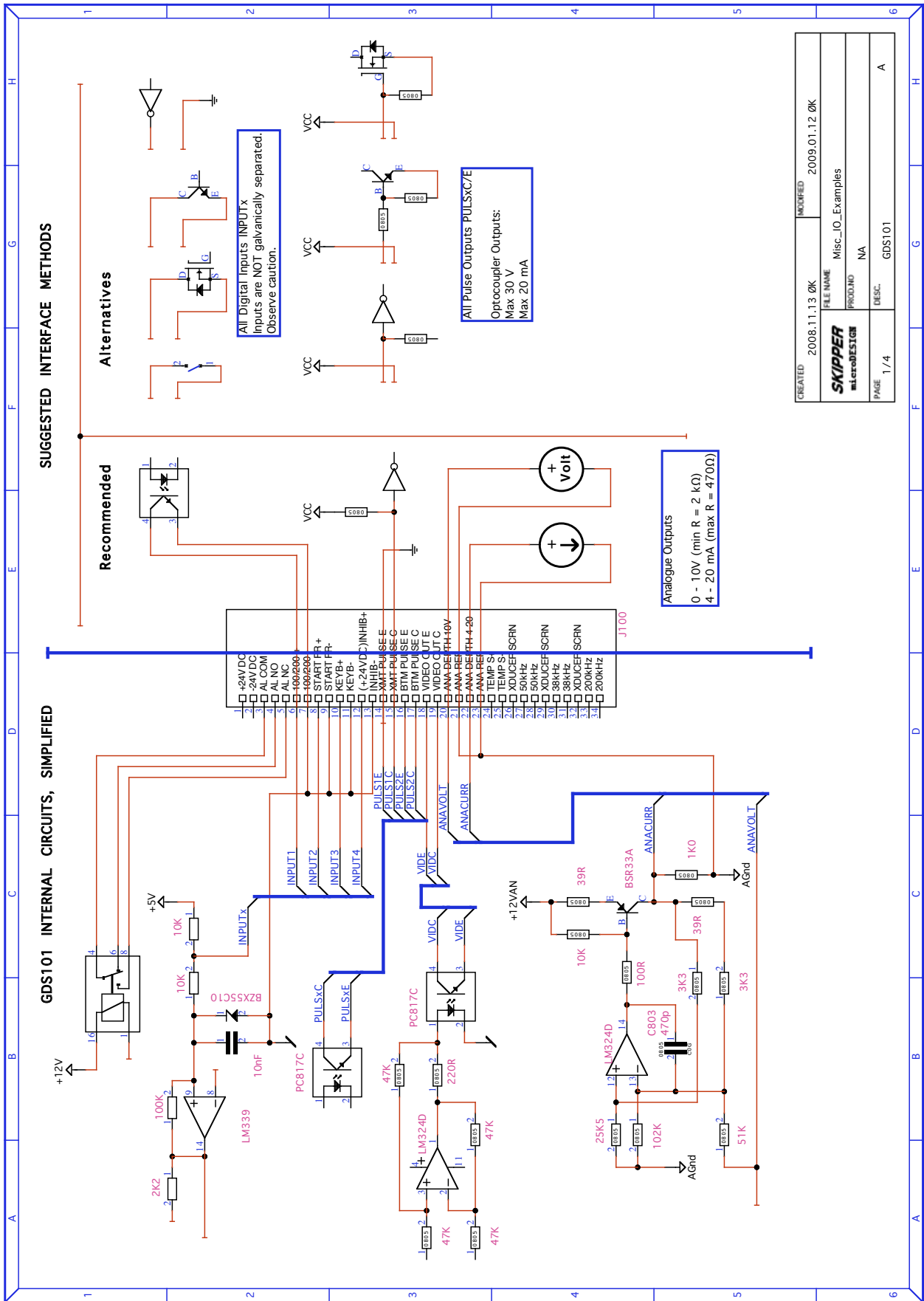

Fig. 4.8. Input/Output Circuitry.

Interfacing

Alarm relay

An alarm relay is provided for interconnection to external alarm systems. This relay is normally energised, and is released by alarm conditions or power failure/power off. See [“Fig. 4.7. Main Wiring Diagram.” on page 43](#), and [“Fig. 4.8. Input/Output Circuitry.” on page 44](#) and [“Fig. 4.11. Alarm interconnections” on page 48](#). The terminals have the following significance:

Name	J100 pin no	Description
ALCOM	3	Common terminal.
ALNO	4	Normally open contact.
ALNC	5	Normally closed contact (Normal = “No alarm” condition).

To comply with MED rules, it is mandatory to connect this output to an audible alarm system.

External alarm reset function

- Can be connected at Keyb+/Keyb-, in parallel with external keyboard (if attached).
- External reset will disengage alarm relay and reset audio alarm (if enabled).
- Visual alarm (blinking digital depth indication on the right side of the screen) is not affected and must be reset locally by pressing any key on the panel.

External alarm reset terminals are as follows:

Name	J100 pin no	Description
KEYB+	10	External alarm reset control input +.
KEYB-	11	External alarm reset control input -.

Log Pulse input

See [“Fig. 4.7. Main Wiring Diagram.” on page 43](#) and [“Fig. 4.8. Input/Output Circuitry.” on page 44](#). Pulse input terminals are as follows:

Name	J100 pin no	Description
100/200 +	6	Log pulse input +.
100/200 -	7	Log pulse input -.

If speed pulses are received on pin 6 -7 while VTG (Track and ground speed) values are received on the NMEA input, it is the pin 6 - 7 values that are shown as speed indication on top of the screen. If these pulses are removed, the NMEA value will be displayed instead.

Refer to [“Fig. 2.7. Screen 6, Interface setup screen.” on page 18](#) for selection of the log pulse rate.

Remote Transducer Selector FEEDB (Feedback)

See [“Fig. 4.7. Main Wiring Diagram.” on page 43](#) and [“Fig. 9.1 Transducer Selector Connection” on page 62](#) and [“Fig. 9.2 Transducer Selector” on page 63](#). Transducer selector control input terminals are as follows:

Name	J100 pin no	Description
STPRINT +	8	Transducer control input +.
STPRINT -	9	Transducer control input -.

Transducer selector FORWARD position: (open - FORWARD/PORT transducer selected).

Transducer selector AFT position: (closed - AFT/STARBOARD transducer selected).

Transmitter trigger pulse and bottom pulse outputs

These outputs can be used to connect a repeater e.g. SKIPPER IR201, or to synchronize other hydroacoustic equipment to avoid interference. See “[Fig. 4.7. Main Wiring Diagram.](#)” on page 43 and “[Fig. 4.8. Input/Output Circuitry.](#)” on page 44. Pulse output terminals are as follows:

Name	J100 pin no	Description
XMIT E	14	Emitter of output opto coupler, transmitter trigger pulse.
XMIT C	15	Collector of output opto coupler, transmitter trigger pulse.
BOTTOM E	16	Emitter of output opto coupler, bottom pulse.
BOTTOM C	17	Collector of output opto coupler, bottom pulse.

Analogue interfaces

GDS101 is equipped with analogue outputs to supply analogue repeaters or other equipment with analogue inputs. See “[Fig. 4.7. Main Wiring Diagram.](#)” on page 43. The signals are galvanically connected to the GDS101. See “[Fig. 4.8. Input/Output Circuitry.](#)” on page 44. Standard range is 0 - 10 V or 4 - 20 mA corresponding to shallow (UPPER) and deep (LOWER) settings. These settings may be accessed on “[Fig. 2.7. Screen 6, Interface setup screen.](#)” on page 18. Analogue outputs from the GDS101 have the following significance:

Name	J100 pin no	Description
ANA 10 V	20	Positive analogue voltage output.
ANA REF	21	Negative analogue reference.
ANA 20 mA	22	Positive analogue current output.
ANA REF	23	Negative analogue reference.

NMEA interface

The NMEA outputs provides IEC 61162-1:2007(E) (NMEA 0183) format depth information to other equipment with NMEA 0183 inputs. Baud rate is 4800 or 9600, 8 bit, no parity. Several messages may be selected on “[Fig. 2.9. Screen 8, NMEA control screen.](#)” on page 20 and the enabled messages are transmitted every second. The NMEA inputs accept position, speed, alarm, heading and UTC time messages from various navigators, compasses or speed logs. The two inputs provided may be connected to different talkers, and both data streams will be received. There are two outputs (both from **COM 1**) that will drive each minimum of 10 standard NMEA 0183 inputs.

Note: Screen 8 NMEA control screen shows in the text window received or transmitted messages on the presently selected channel (COM 1 or COM 2).

The NMEA 0183 outputs and inputs are available on the XJ303 9 Pin connector according to “[Fig. 4.9. NMEA connector XJ303.](#)” on page 46, “[Fig. 4.10. Data Communication Interfaces.](#)” on page 47 and “[Fig. 4.12. External Interface Ports](#)” on page 49. See “[NMEA Setup](#)” on page 52 for a complete list of transmitted and received messages.

9 Pin D-SUB (female connector) in cabinet front seen from outside.

- **COM 1:** Pin 1-2 (RCV1 A, B), Pin 4-5 (XMT1 A, B) and 8-9 (XMT2 A, B)
- **COM 2:** Pin 6-7 (RCV2 A, B)

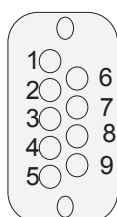

NMEA IN: Pin 1-2, RCV1 A, B
 NMEA IN: Pin 6-7, RCV2 A, B
 NMEA OUT: Pin 4-5, XMT1 A, B
 NMEA OUT: Pin 8-9, XMT2 A, B

Fig. 4.9. NMEA connector XJ303.

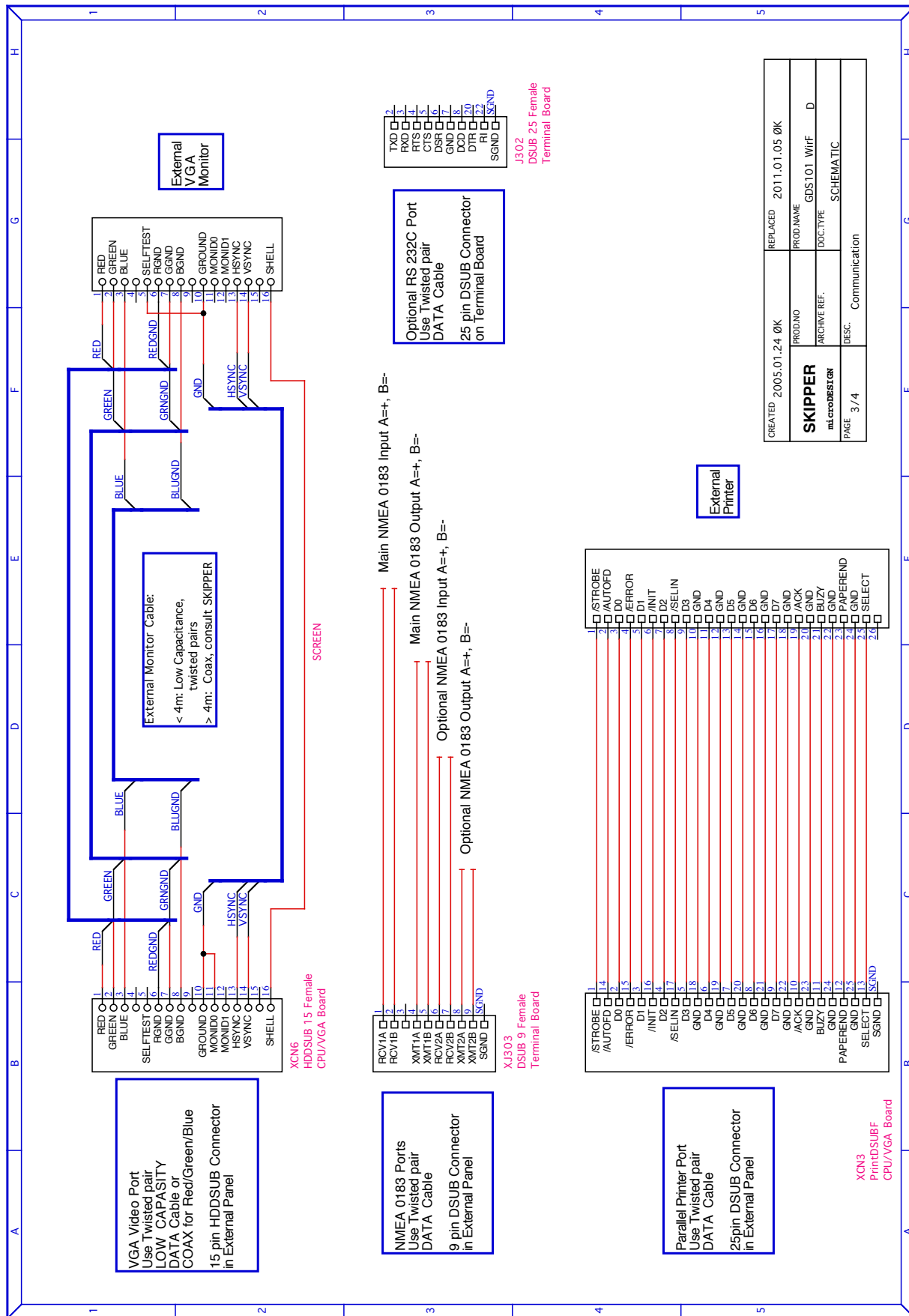

Fig. 4.10. Data Communication Interfaces.

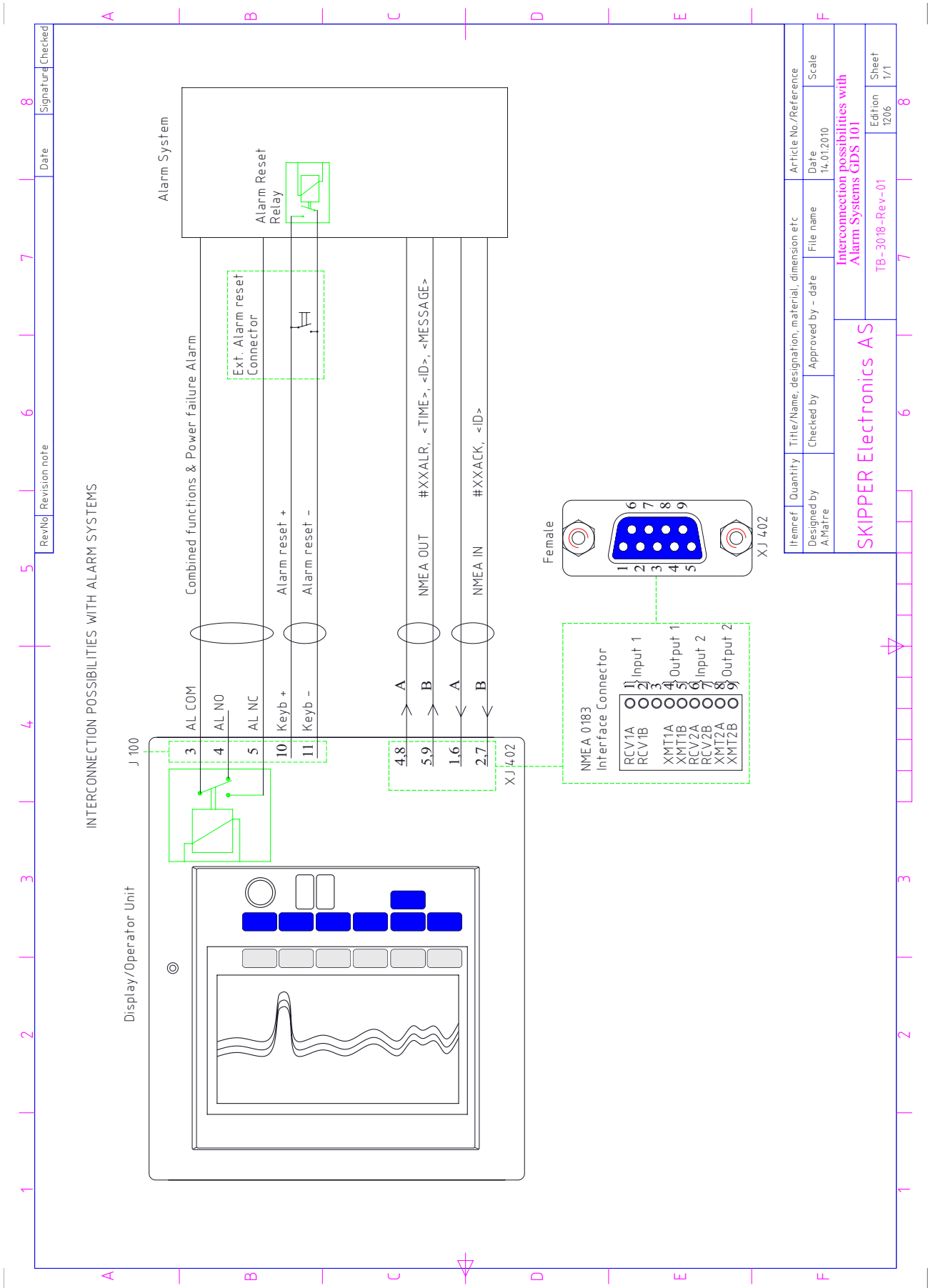

Fig. 4.11. Alarm interconnections

External Interface Ports



Ground Stud. 5 x PG 13.5 cable entry 10-12 mm.

XJ303: NMEA ports D-type 9 pin female.

XCN6: VGA terminal HDD D-type 15 pin female.

XCN3: Printer port D-type 25 pin female.

Also, see [“Fig. 4.9. NMEA connector XJ303.”](#) on page 46 and [“Fig. 4.10. Data Communication Interfaces.”](#) on page 47.

Fig. 4.12. External Interface Ports

Options

Repeaters/Slaves

Graphic CRT (VGA), LCD displays or digital depth slave repeaters may be connected to the system. Along with the graphic display repeaters, there may also be installed remote keyboard. The graphic repeaters require the installation of line driver units dependant on the distance between the main system and the repeater. See [“Fig. 4.7. Main Wiring Diagram.” on page 43](#) and [“Fig. 4.10. Data Communication Interfaces.” on page 47](#).

Remote Keyboard

The unit may optionally be operated from a remote keyboard/hand controller. See [“Fig. 4.7. Main Wiring Diagram.” on page 43](#)

Name	J100 pin no	Description	Hand controller cable colour
KEYB+	10	Keyboard signal.	Blue.
KEYB-	11	Keyboard reference.	Yellow and black.
INHIB+ (+12 V DC)	12	Keyboard power.	Red.

Note: When connecting remote keyboard/hand controller, make sure jumper JP200 is present on the Power terminal board. This jumper provides +12 V DC to J100 pin 12 (INHIB+).

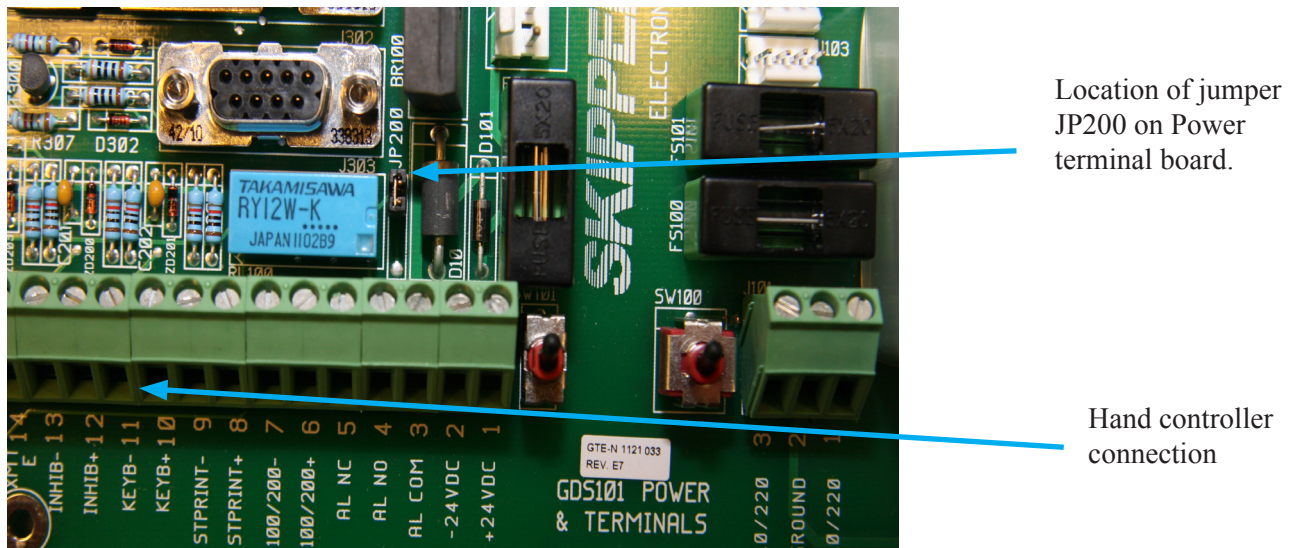

Remote Sounding Control.

This option lets the GDS101 being controlled remotely in synchronised (edge), burst (level) or single ping modes. If installed, these options are accessible on [“Fig. 2.4. Screen 3, 3rd Operation screen.” on page 15](#). Also see [“Fig. 4.7. Main Wiring Diagram.” on page 43](#) and [“Fig. 4.8. Input/Output Circuitry.” on page 44](#).

Sounder remote control terminals are as follows:

Name	J100 pin no	Description
INHIB +	12	Control Signal Input +.
INHIB -	13	Control Signal Input -.

Refer to [“Fig. 2.7. Screen 6, Interface setup screen.” on page 18](#) for selection of the control signal polarity.

Note: With the present hardware, it is not possible, at the moment, to use “Remote Keyboard” and “Remote Sounding Control” (Navy option) simultaneously.

5. Start-up and system Adaption

System Adaptation

Analogue Output and Log Pulse Input Range Selection

From “[Fig. 2.7. Screen 6, Interface setup screen.](#)” on page 18 it is possible to set number of pulses per nautical mile (100, 200, 400 and 20000) for the log pulse input. Shallow (UPPER) and deep (LOWER) range limits for the analogue output may also be set, e.g.

- 50 m corresponding to 10 V or 20 mA.
- 0 m corresponding to 0 V or 4 mA.

Language and Units of Measure

From “[Fig. 2.6. Screen 5, Language and units of measure setup.](#)” on page 17 it is possible to select different languages and units of measure for the screen and printer character strings. The available languages are: English, French, Spanish, Russian, German and Norwegian.

Units of measure may be selected for:

Depth	meters, feet, fathoms, braccias.
Picture speed	min:sec, (*nm/div, *km/div, *miles/div). *Only possible if an external speed log is connected.
Vessel speed	knots, km/h, miles/h.
Sound speed	m/s, feet/s

Remote Transducer Selector

See “[Fig. 9.1 Transducer Selector Connection](#)” on page 62 and “[Fig. 9.2 Transducer Selector](#)” on page 63. Transducer selector control input terminals are as follows:

Name	J100 pin no	Description
STPRINT+	8	Transducer control input +.
STPRINT-	9	Transducer control input -.

STPRINT-/STPRINT+ input is processed as transducer selector input (open - FORWARD/PORT transducer selected, closed - AFT/STARBOARD).

Low frequency indication

When the 38 kHz transceiver channel has been modified to a different frequency, is it possible from “[Fig. 2.6. Screen 5, Language and units of measure setup.](#)” on page 17 to adjust indicated value. Soft key SET LOW has five preset values (24/28/30/33/38 kHz) and encoder must be used to set any other value in the range of 10 - 250 kHz, when desired. Note that the 38 kHz channel must be activated first (see “[Fig. 2.3. Screen 2, 2nd Operation screen.](#)” on page 14, button “FREQUENCY”).

Note: After master reset procedure, the value is reset to factory default, and should be re-entered, if the actual value is different. For master reset, see “[Master Reset Procedure](#)” on page 60.

NMEA Setup

“[Fig. 2.9. Screen 8, NMEA control screen.](#)” on page 20 is used for verification of received and control of transmitted NMEA messages. Two digital communication channels are provided:

- **COM 1** Primary NMEA 0183, (XJ303, RCV1 A/B-XMT1 A/B-XMT2 A/B).
- **COM 2** Secondary NMEA 0183/RS-232, (XJ303 NMEA: RCV2 A/B) and J302 (RS-232).

Each channel can be programmed individually with respect to the baud rate and scope of transmitted messages. Before configuration of the required channel, it must be selected by using the soft key IN/OUT. Primary channel is called COM 1, and secondary called COM 2. **Note:** Due to the present hardware configuration, the NMEA sentences selected for COM 1 will transmit from both XMT1 and XMT2. Settings set in COM 2 will only be present in the RS-232 output. The text window will represent information, which corresponds to the currently selected channel. The type of displayed messages received from external talker (if connected) or transmitted by the sounder, is selectable by using the soft key DISPLAY input/output. For more easy analysis of the window contents, display can be prevented from continuous update, if “DISPLAY off” is selected. The baud rate may be set to 4800 or 9600, 4800 being the more common. Transmitted messages are enabled individually by soft keys MESSAGE and STATUS. To enable/disable particular message, select it from the list by pressing MESSAGE button until required message appears on the same button and then select the status of this message (on/off) by pressing STATUS button. It is advisable at this stage to set display in “output” mode, to be able to observe current scope of transmitted messages. Transmitted talker identifier is SD, Sounder Depth.

NMEA transmitted/output messages

Depth & Draught	\$SDDPT,xxxx.x,xxxx.x,xxxx.x*hh<CR><LF>
Depth below surface	\$SDDBS,xxxx.x,f,xxxx.x,M,xxx.x,F*hh<CR><LF>
Depth below transducer	\$SDDBT,xxxx.x,f,xxxx.x,M,xxx.x,F*hh<CR><LF>
Depth below keel	\$SDDBK,xxxx.x,f,xxxx.x,M,xxx.x,F*hh<CR><LF>
1) Multiple transducer installation	\$SPKPDPT,x.x,x.x,x.x,xx,xx,c-c*hh<CR><LF>
Check sum on/off	CHECK SUM
Proprietary Skipper command for Kongsberg/Simrad EN250. Note: Normally not used on GDS101.	EN250
Proprietary Skipper command for Kongsberg/Simrad EN250. Note: Normaly not used on GDS101.	EN250 D#
[Fore/Aft] transducer	\$SDXDR,D,x,x,M,c-c,<Cr><Lf>
Set alarm state	\$SDALR,hhmmss.ss,xxx,A,A,<Alarm message> *hh<CR><LF>

1) In case of multiple transducer installation, the following SKIPPER proprietary sentence must be selected:

\$SPKPDPT,x.x,x.x,x.x,xx,xx,c--c*hh<CR><LF>	
	Check sum, possible to turn on/off (see screen 8)
	Transducer location *
	Echo sounder channel number (0-99)**
	Bottom echo strength (0,9)
	Maximum range scale in use, meters
	Offset from transducer, meters
	Water depth relative to transducer, meters

* Text string, indicating transducer position: FWD/AFT/PORT/STB. If position is not preset by operator, empty field is provided.

- ** = 1 - 38 kHz
- = 2 - 50 kHz
- = 3 - 200 kHz

NMEA received/input messages

The talker identifier is ignored:

Time

Universal Time	ZZU,xxxxxx
Universal Time & Local	ZLZ,xxxxxx,xxxxxx,-xx
Day, Month, Year	ZDA,xxxxxx,xx,xx,xxxx,-xx

The time values will be indicated in the upper left corner of the screen, example: 11:43.

Position

Geographical Lat/Lon	GLL,xxxx.xx,N,xxxx.xx,W
Geographical Fix, present	GXP,xxxxxx,xxxx.xx,N,xxxx.xx,W,cccc,x
Loran C Fix, present	GLP,xxxxxx,xxxx.xx,N,xxxx.xx,W,cccc
GPS Position	GGA,xxxxxx,xxxx.xxx,N,xxxx.xxx,W,x

The position values will be indicated on top of the screen, right side, example: E059° 13.12' N010° 57.34'.

Heading

Heading, true, present	HDT,xxx.,T
Heading, magnetic, present	HDM,xxx.,M
Heading, compass	HCC,xxx.

The heading values will be indicated on top of the screen, right side, example: 123.0°.

Alarm

Acknowledge alarm	ACK,xxx*hh<CR><LF>
-------------------	--------------------

Speed

Dual ground/Water speed	VBW,uxx.xx,uxx.xx,a,uxx.xx,uxx.xx,a
-------------------------	-------------------------------------

The speed value will be indicated on top of the screen, right side, example: 15.55 kts.

Composite

Loran C specific	RMA,a,xxxx.xx,N,xxxx.xx,W,,xx.x,xxx.,*xx
GPS, Transit specific	RMC,xxxxxx,a,xxxx.xx,N,xxxx.xx,W,xx.x,xxx.,xxxxxx,*xx
Track & Ground speed	VTG,xxx.,T,xxx.,M,xx.x,N,xx.x,K
Heading & Water speed	VHW,xxx.,T,xxx.,M,xx.x,N,xx.x,K

The composite values will be indicated on different positions on top of the screen, depending on message type.

Simulation PSKP message

Start/stop simulation mode	\$PSKPSIM,x.x*[CS][CR][LF] where x.x is a simulated depth value.
----------------------------	------------------------------------------------------------------

The proprietary SKIPPER PSKP NMEA message is used to start and stop depth simulation mode. The message format is \$PSKPSIM,x.x*[CS][CR][LF], where x.x is a simulated depth value.

If the depth value is valid (0 - 1600 m), GDS101 will get into simulation mode, where this value is used for all indications and outputs (analogue, NMEA, bottom pulse). The “synthetic” bottom pulse which is generated can be observed on the echogram, [“Fig. 2.11. Screen 10, Oscilloscope screen.” on page 22](#). The label “SIMUL” is blinking in the lower line - to indicate simulation mode. If the depth value is not valid (greater than the max range of 1600 m, or empty), the simulation mode will be turned off.

Options

Calibration, Sound Speed

The only calibration activity necessary is when the sound speed option is installed. In this case, set the required sound speed value in [“Fig. 2.4. Screen 3, 3rd Operation screen.” on page 15](#).

External Ping Control

When this option is installed, transmitter operation may be controlled by the external INHIBIT signal. The active polarity of this signal may be set on [“Fig. 2.7. Screen 6, Interface setup screen.” on page 18](#). The following function options are available on [“Fig. 2.4. Screen 3, 3rd Operation screen.” on page 15](#):

PING

Continuous	Transmitter operation is continuous and not affected by the external signal.
Edge	The transmitter is activated <u>once</u> by an active signal edge.
Level	The transmitter is controlled by the external signal level. An active level keeps the transmitter running, a passive level stops the transmitter.
Single	The transmitter is activated ping by ping by pressing the PICTURE SPEED button on the operator panel. The external INHIBIT signal is disabled.

6. Specifications, Dimensions

Transducer, 38 kHz	Diameter.	181 mm.
	Mounting.	Tank/sea valve/ice tank.
	Cable length.	40 m.
	Weight.	ca. 20 kg.
	Protection.	IP 68.

Transducer, 50 kHz	Diameter.	90 mm.
	Mounting.	Tank/sea valve/ice tank/aluminium tank.
	Cable length.	25 m or 40 m.
	Weight.	ca. 7 kg.
	Protection.	IP 68.

Transducer, 200 kHz	Diameter.	140 mm.
	Mounting.	Tank/ice tank.
	Cable length.	25 m or 40 m.
	Weight.	ca. 8 kg.
	Protection.	IP 68.

Transducer, 200 kHz	Diameter.	90 mm.
	Mounting.	Tank/sea valve/ice tank/aluminium tank.
	Cable length.	25 m.
	Weight.	ca. 7 kg.
	Protection.	IP 68.

Transducer Junction Box	Size incl. glands.	132 x 111 mm.
	Depth.	55 mm.
	Weight.	0.6 kg.
	Protection.	IP 56.

Operator unit cabinet	Height, front.	340 mm.
	Width.	320 mm.
	Depth.	170 mm.
	Weight.	ca. 10 kg.
	Protection.	IP 42.

Functional Properties

Display.	10,4" 158 x 211 mm graphic LCD screen with adjustable day/night vision and backlight. 640 x 480 pixels.
Printer.	HP Deskjet, Epson D88 or Epson LQ300.
Depth alarms.	Deep and shallow limits.
Calendar/Clock.	Year-month-day/hours-minutes-seconds (24 hour system).
Interface outputs.	Transmitter trigger pulse and bottom pulses.
	Analogue 4 - 20 mA and 0 - 10 V for depth. Detected video.
	IEC 61162-1:2007(E) (NMEA 0183) for alarm and depth.
	Alarm relay.
	Output for VGA repeater.
	RS-232 C.
	PC parallel printer port.
Interface inputs.	100/200/400/20000 pulses for speed.
	IEC 61162-1:2007(E) (NMEA 0183) for speed, position, alarm, heading and time.
	Remote alarm reset.
	Remote transducer selector.
Languages.	English, French, Spanish, Russian, German and Norwegian.
Options.	VDR (Voyage Data Recorder) or IR301 digital remote depth indicator.
	LCD repeater.
	Remote keyboard.
	Remote sounding control.
	Autorange.
	Sound speed calibration.

Performance

Depth range.	0 - 1600 m.
Graphic resolution.	0.5 % of range.
Digital screen resolution.	<10 m: 0.01 m.
	>= 10 m <100 m: 0.1 m.
	>= 100 m: 1 m.

Transducer, 24 kHz/38 kHz.	Beam angle.	16°/20° conical.
	Max. power.	24 kHz = 1.5 kW/38 kHz = 1.0 kW.
	Effective range.	3000 m/1500 m.
Transducer, 50 kHz.	Beam angle.	33° conical.
	Max. power.	1 kW.
	Effective range.	750 m.
Transducer, 200 kHz.	Beam angle.	6° conical.
	Max. power.	1 kW.
	Effective range.	350 m.
Transducer, 200 kHz.	Beam angle.	10° conical.
	Max power.	1 kW.
	Effective range.	350 m.

Environmental according to IEC60945:

Transducer and Junction Box

Operating temperature.	-15 - 55 degree C IEC 60945.
Storage temperature.	-20 - 70 degree C.
Protection, transducer.	6 bar, IP 68.
Protection, junction box.	IP 56.

Operator Unit Cabinet

Supply voltage.	230 V (195 - 253 V AC) or 115 V (96 - 125 V AC).
	24 V DC (20 - 32 V).
Power consumption.	50 W at 24 V, 70 W at 230 V AC or 115 V AC.
Alarm relay.	Change-over contact, max. 24 V 300 mA.
RS-232 C port.	Standard 25 pin D - type connector (located on terminal PCB inside cabinet).
NMEA port.	9 pin D - type. 2 inputs, 2 outputs.
Operating temperature.	-15 - 55 degree C according to IEC60945.
	To increase serviceability and life-time, we suggest the working temperature to be held at 0 - 40 degree C.
Storage temperature.	-20 - 70 degree C.
Humidity.	10 - 90 % relative, no condensation.
Protection.	IP 42.
Measuring accuracy	Better than 1 %.

7. Service

- All service requests should be made to your local representative or to the manufacturer. (Contact information on title page).
- Adjustments and repairs should only be performed by qualified service engineers.
- Unqualified repair attempts will void the warranty.

8. CPU Board Setup Procedure

- Connect a PC keyboard and a VGA screen to the CPU board.
- Switch “On” the unit while pressing “Delete” key on the PC keyboard.
- Do not release the “Delete” key before the “Setup” picture is present on the screen.

CPU PCA 6742VE

(Bios version 1.12). The PCA 6742 has the default settings with the following changes. Start by loading the optimized defaults, and then change the following:

STANDARD CMOS FEATURES

Date: Change to today's date

Time: Change to time now

Halt on: No errors

Advanced BIOS Features

- a. Hard Disk priority [Press enter] – Press enter
 - i. 1 should be ch.1 M.
 - ii.2 should be ch 0 M.
- b. First Boot Device [Hard Disk]
- c. Second Boot Device [Hard Disk]
- d. Boot other device [Disabled]

Advanced Chipset features

- a. SMI712 VGA Settings [Press Enter] – Press enter
 - i. SMI712 VGA Monitor [Simul monitor]
 - ii. Panel resolution Mode [640x480 TFT]
- b. USB Device Setting [Press Enter] – press enter
 - i. USB1.0 emulation [Disabled]

Integral Peripherals

- a. Onboard serial Port 3 [enter]
 - i. Change to [2E8/IRQ9]
- b. Onboard serial Port 4 [enter]
 - i. Change to [3E8/IRQ5]
- c. Parallel Port Mode [EPP]
- d. EPP Mode Select [EPP1.9]

PnP/PCI Configurations

- a. Resources Controlled By [Manual]
- b. IRQ Resources [Enter]
 - i. IRQ – 7 assigned to [Legacy ISA]
 - ii. IRQ – 10 assigned to [Legacy ISA]
 - iii. IRQ – 11 assigned to [Legacy ISA]
- c. NO DMA

PC Health Status

- a. Case Open Warning [Disabled]

SAVE SETTINGS AND EXIT

Master Reset Procedure

After completed setup procedure, you should always do a ‘‘MASTER RESET’’:

- Switch off the GDS101, using the internal toggle switch and wait a few seconds.
- Then press down and keep pressed the soft key to the far right and far left (no. 1 and 6) in the upper row on the GDS101 keyboard.
- Turn the GDS101 ‘‘on’’ and keep the two soft keys pressed down until you hear 4 ‘‘beeps’’ and then release the keys.

Upgrading Software

New software versions are released from time to time. The GDS101 with Compact Flash (CF) can be updated by performing the following software upgrade procedure.

1. If you have received a programmed compact flash, skip stage 2.
2. Newest software may be downloaded from the web <http://www.skipper-service.no/skipdoc/skipdoc.php>. Under ‘‘software’’ you will find your equipment type. Also copy the latest version of startup.exe into the root folder.

Note: Standard Compact Flash reader is needed to be attached to the PC.

Note: It is possible to use the Compact Flash card, which is already installed in the display unit.

3. Switch Off the mains of the display unit and insert Compact Flash card with the new software on it.
4. Press the ‘‘hidden’’ button inside the cabinet (mounted on the solder side of the keyboard). Keeping the ‘‘hidden’’ button pressed, switch On the mains in the display unit and keep the button pressed until the message ‘‘You may release the upgrade button’’ appears in the lower part of the screen. If a new setup.exe is to be loaded, follow the on screen instructions.
5. Release the hidden button. After few diagnostic text messages, the list of available software versions will appear in the lower part of the screen as in example below.
6. Note: If the bootloader does not find any file with the software on the Compact Flash, the presently installed version will start automatically. In this case, make sure that the upgrade and setup file has been copied correctly on the Compact Flash and repeat the procedure.

05.05.16	05.05.15
External	Active

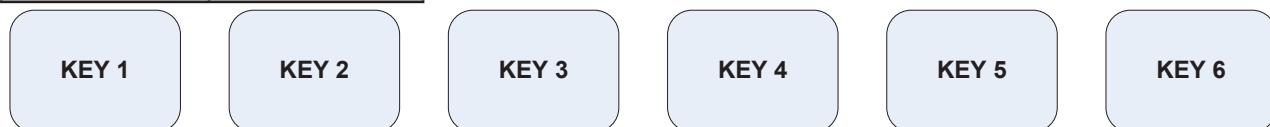

7. Select a software version, which you would like to install. Normally, it is possible to chose one out of two: 1) The version, which is currently installed in the internal memory (indicated as Active) and 2) the upgrade version (indicated as External). The version name is displayed in the upper line of the text lines, located just above the corresponding soft key. In the example above, soft key 1 should be pressed to select the latest software version.
8. Confirm selection by pressing YES button (or go back to selection, pressing NO).
9. Press any button to start the upgraded software (or it will start automatically in 5 seconds).
10. Note: The file with a previous software version will be copied back to the Compact Flash card, so it would be possible to re-install it in the similar manner, if desired.

Note: Always turn off the unit with the switch on the Terminal board when removing/replacing the CF disk.

9. Appendix, Miscellaneous Drawings

For repeater and repeater dimmer, see separate manual: IR301 manual

For tank and sea valve, see separate manuals:

ETNSLJB-manual.	Single bottom sea valve (discontinued from 2007).
SB-100-manual.	Single bottom sea valve.
DB-100-manual.	Double bottom sea valve.
SB-200-manual.	For 24 and 38 kHz transducer deep sea.
Standard tank inst manual.	For 50 and 200 kHz transducer.
Combo tank inst manual.	For 24 and 38 kHz transducer deep sea. For different type of transducers, custom design is possible.

All manuals (examples below) available on manufacturers homepage. (See title page for details).

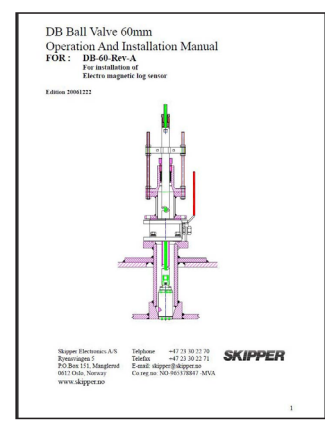
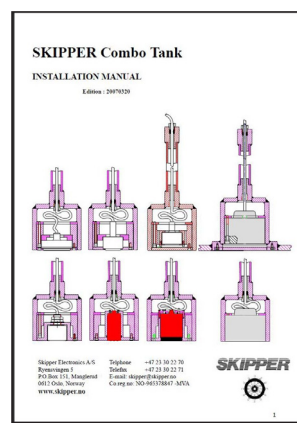
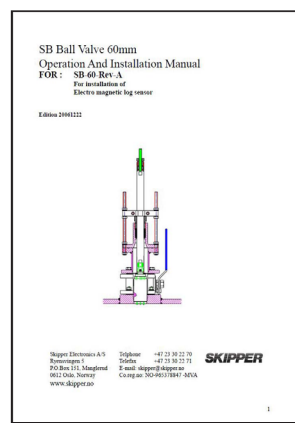
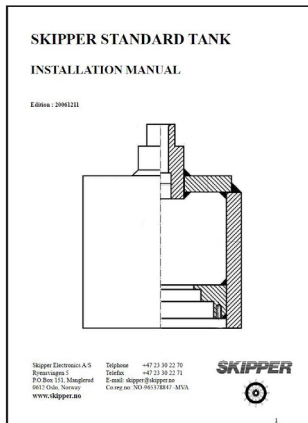

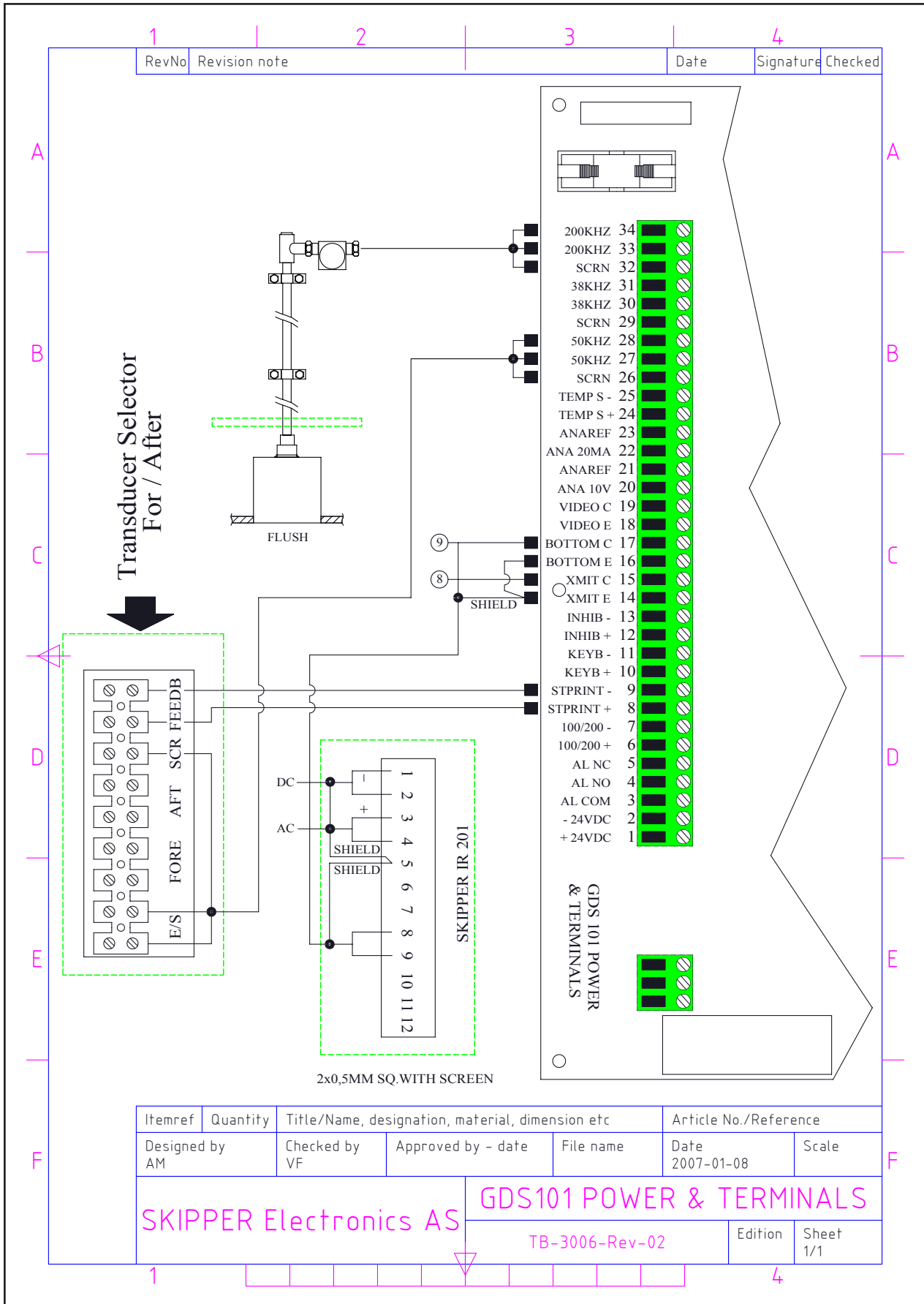

Fig. 9.1 Transducer Selector Connection

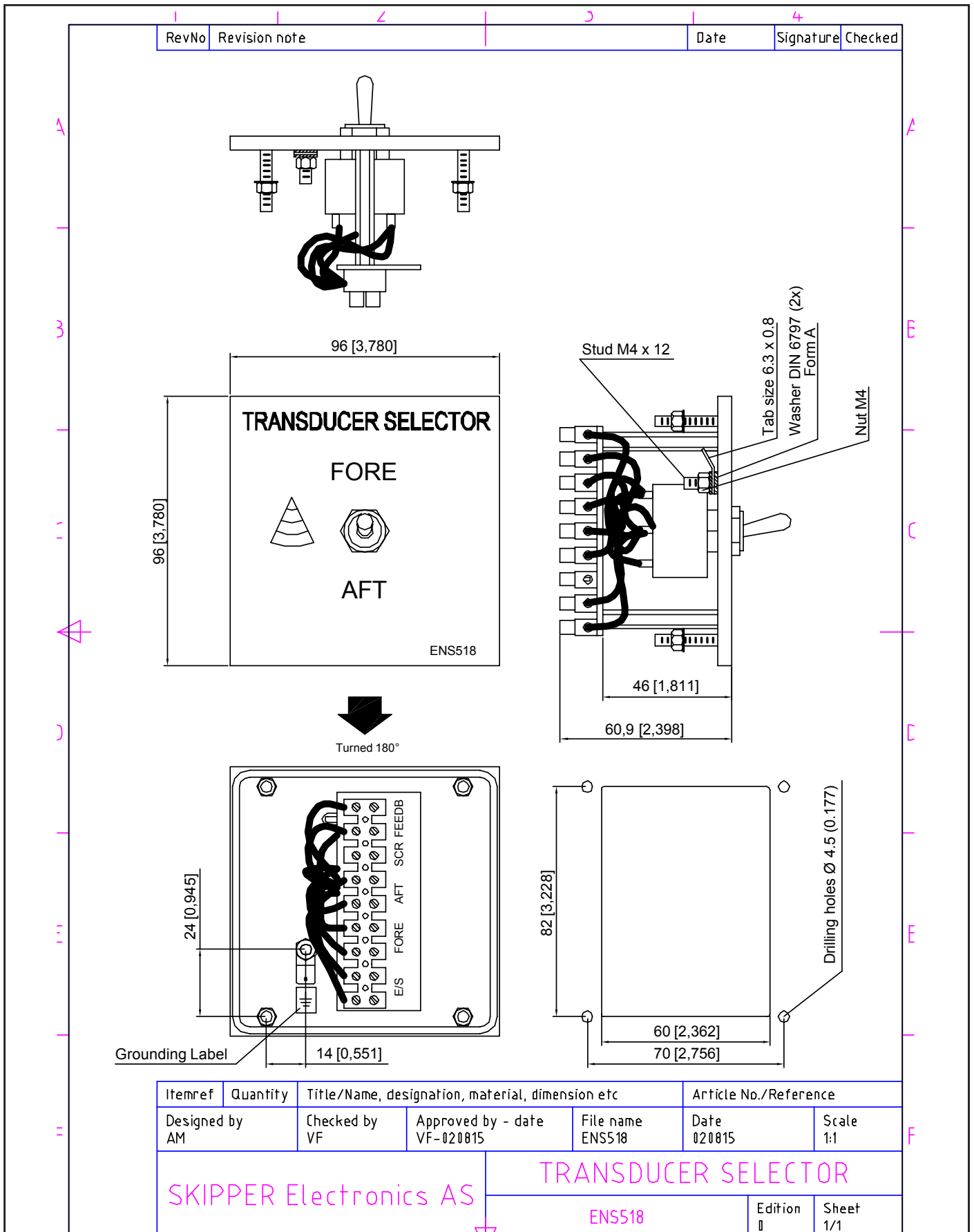

Fig. 9.2 Transducer Selector

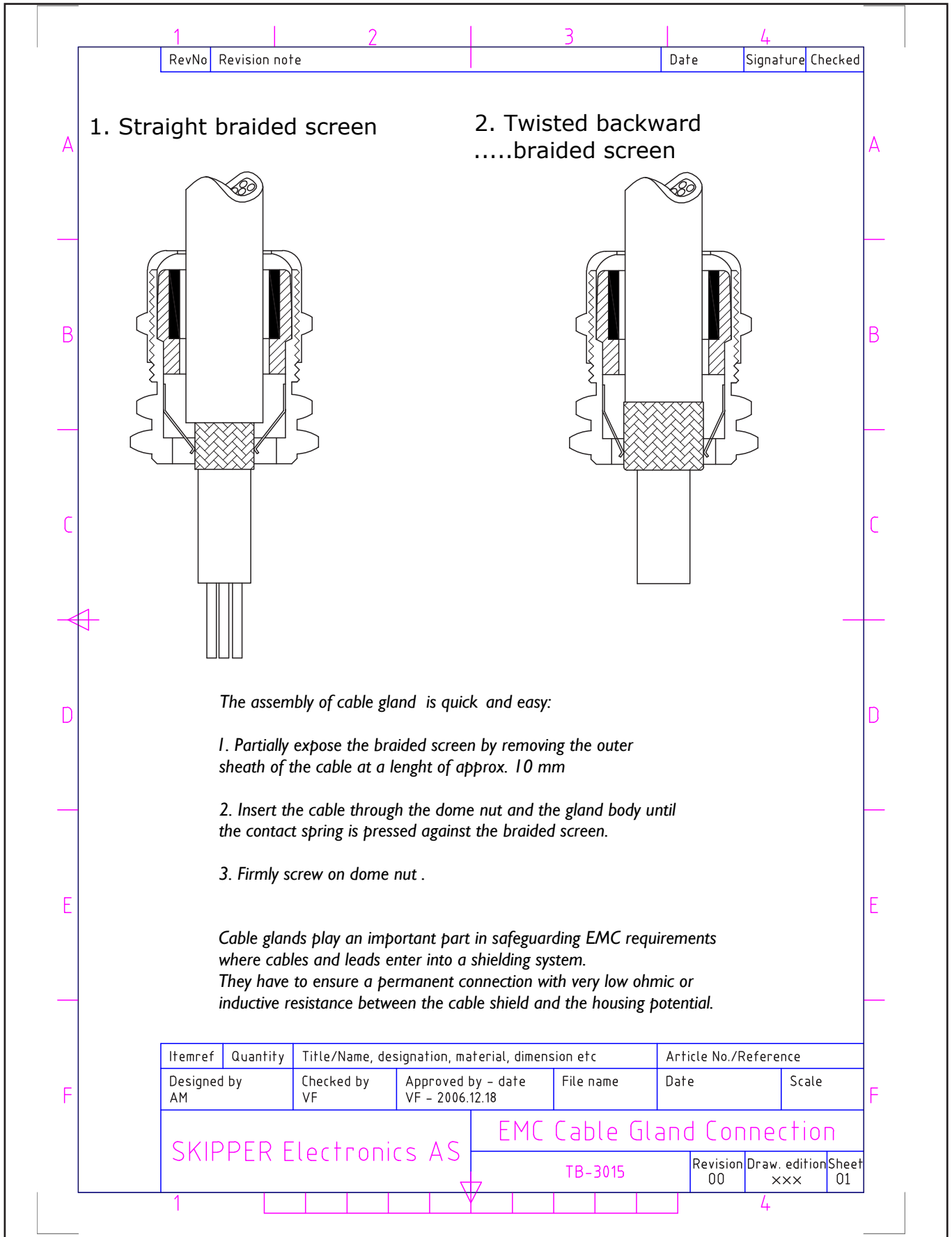

Fig. 9.3 Cable Gland Connection

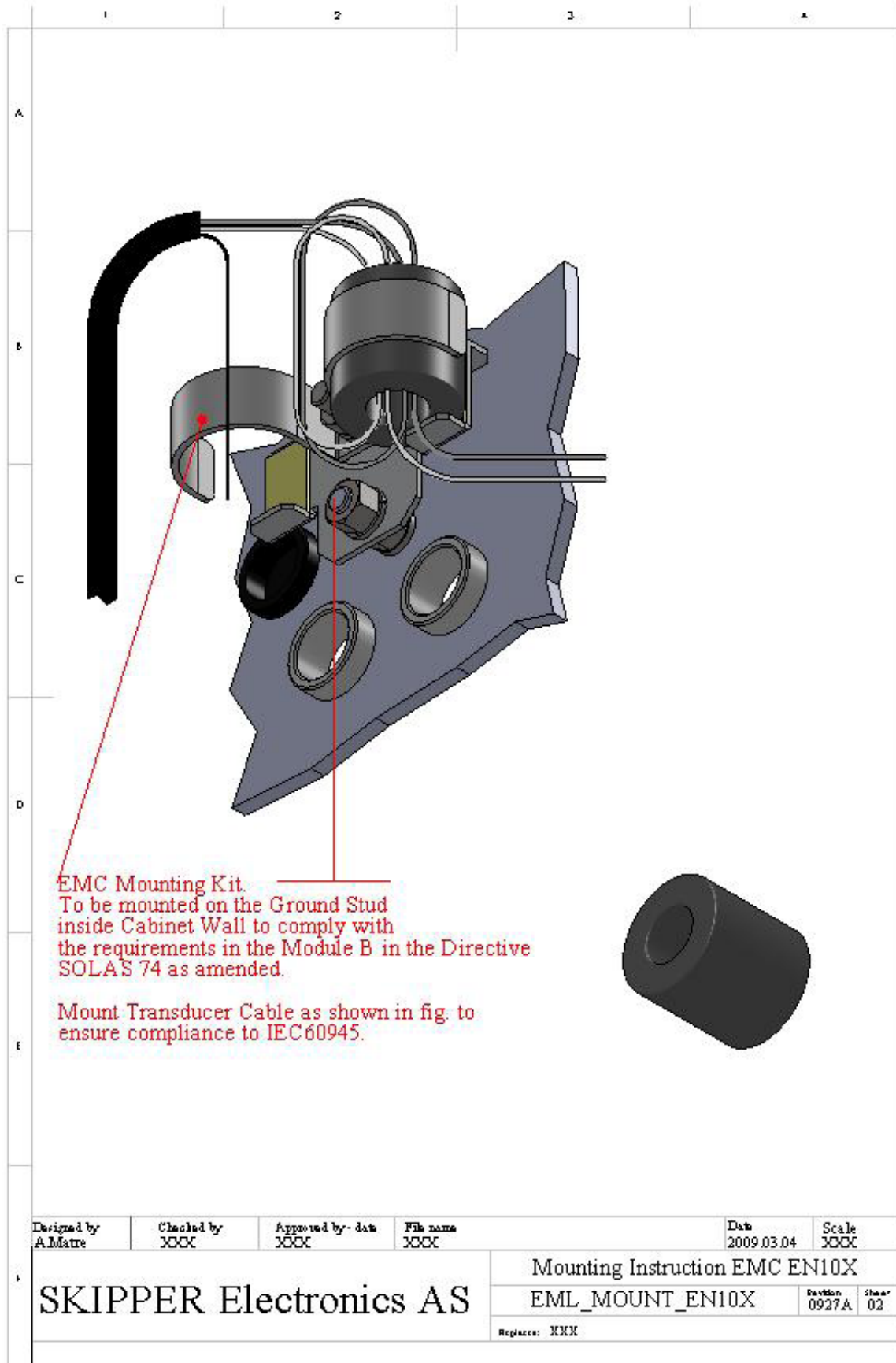

Fig. 9.4 EMC Mounting Kit

10. Warranty and Utilization

Warranty:

- SKIPPER Electronics AS gives 12 months limited guarantee on all deliveries from SKIPPER Electronics AS, Norway.
- Please note that if the equipment is delivered by a third party, the third party's warranty conditions may apply.
- All warranty request should be sent to the local supplier of the equipment.

Utilization:

- This equipment is not to be disposed in normal waste, but be handled in accordance with applicable waste disposal regulations in the country where the equipment is used.

12. Index

Symbols

115/230 V Selection 39

A

Alarm 53
 ALARM ▲ 13
 ALARM ▼ 13
 Alarm acknowledgement 27
 Alarm ID 27
 ALARM ID 18
 Alarm interconnections 48
 Alarm relay 45
 Alarms 9
 Alarm Settings 26
 Analogue interfaces 46
 Analogue Output and Log Pulse Input Range Selection 51
 Appendix, Miscellaneous Drawings 61
 AUDIO ALR 21
 Audio warning 27
 Auto Range 9, 29
 AUTORANGE 15

B

Basic Functionality 34
 Basic System Configuration 36
 Basic System Integrity 30
 BAUD 20
 Bottom detection 23
 Bottom Search Range 23

C

Cable Gland Connection 64
 Calibration, Sound Speed 54
 Clock and Calendar Settings 27
 Composite 53
 CPU Board Setup Procedure 59
 CPU PCA 6742VE 59

D

Data Communication Interfaces 47
 DAY 16
 Day/Night and back light adjustment 24
 DEPTH 17
 Depth Range 24
 DIGITAL 14
 Digital indication 25
 Dimensions 55
 DISPLAY 20
 Draught 25
 DRAUGHT 15

E

EMC 39
 EMC Mounting Kit 65

ENABLE 18
 Environmental according to IEC60945: 57
 Example of parameter entry 12
 Extended 27
 External alarm reset function 45
 External Interface Ports 49
 External Ping Control 54
 External Printer 29
 External Printer Operation 26

F

Fig. 1.1 Main Display Unit Panel Layout 7
 Fig. 1.2 System Diagram 8
 Fig. 1.3 GDS101 Primary Functions 10
 Fig. 2.1 Setting and Parameter Entry Flowchart 11
 Fig. 2.2. Screen 1, Primary Operation screen. 13
 Fig. 2.3. Screen 2, 2nd Operation screen. 14
 Fig. 2.4. Screen 3, 3rd Operation screen. 15
 Fig. 2.5. Screen 4, Calendar and clock setting. 16
 Fig. 2.6. Screen 5, Language and units of measure setup. 17
 Fig. 2.7. Screen 6, Interface setup screen. 18
 Fig. 2.8. Screen 7, History Memory Control Screen. 19
 Fig. 2.9. Screen 8, NMEA control screen. 20
 Fig. 2.10. Screen 9, System status screen. 21
 Fig. 2.11. Screen 10, Oscilloscope screen. 22
 Fig. 4.1. Basic System Configuration. 36
 Fig. 4.2. Transducer Junction Box. 37
 Fig. 4.3. Operator Unit. 38
 Fig. 4.4. Voltage selection connectors and fuses, terminal board. 40
 Fig. 4.5. History Memory Battery Jumper, I/O Board. 41
 Fig. 4.6 Function LEDs, Terminal, I/O and CPU Boards. 42
 Fig. 4.7. Main Wiring Diagram. 45
 Fig. 4.8. Input/Output Circuitry. 44
 Fig. 4.9. NMEA connector XJ303. 46
 Fig. 4.10. Data Communication Interfaces. 47
 Fig. 4.11. Alarm interconnections 48
 Fig. 4.12. External Interface Ports 49
 Fig 9.1 Transducer Selector Connection 62
 Fig 9.2 Transducer Selector 63
 Fig 9.3 Cable Gland Connection 64
 Fig 9.4 EMC Mounting Kit 65
 Fixed Key Functions 24
 FIX RANGE 21
 Frequency 25
 FREQUENCY 14
 Functional Properties 56

G

Gain 25
 GAIN 13, 22
 GDS101 Primary Functions 10

H

Hand controller connection 50
 Heading 53

Heading indication from GPS 33
HIST. FRMT 19
HIST. HOUR 19
HIST. MIN 19
HISTORY 19
History Memory 27
History Memory Battery Jumper, I/O Board. 41
HOURS 16

I

Important note 39
IN/OUT 20
Input/Output Circuitry 44
Inputs 9
Installation 35
Interfacing 9, 45
Introduction 6

L

LANGUAGE 17
Language and Units of Measure 51
Location 35
LOCATION 22
Log Pulse input 45
Loop 27
LOWER 18
Low frequency indication 51

M

Main Display Unit Panel Layout 7
Main Wiring Diagram 43
MARK 13, 14, 19
Master Reset Procedure 60
MESSAGE 20
MINUTES 16

N

NMEA connector XJ303 46
NMEA interface 46
NMEA Interface etc. 34
NMEA OUT 18
NMEA received/input messages 53
NMEA Setup 52
NMEA transmitted/output messages 52
Nonvolatile Parameter Memory 28
Note 9, 14, 15, 16, 17, 18, 23, 25, 27, 29, 31, 35, 41, 46, 50, 51, 60
Notes 67

O

Operation 11
Operation Screens 12
Operator Panel and Data Entry 6
Operator Unit 38
Operator Unit Cabinet 57
Operator Unit Installation 38

Operator Unit Maintenance 30
Options 9, 28, 50, 54
Oscilloscope Screen 28
Output Power 25
Outputs 9

P

Parameter entry 11
Performance 56
PICT.SPEED 17
Picture Speed 24
PING 15, 54
Ping to Ping filtering 23
Position 53
Position from GPS 33
POWER 15, 22
Power indication and function LEDs 42
Primary Operation Screens 13
Principal Functions 23
PRINT 13, 14
PRINTER 16, 21
PULSE 18

R

Recorded Data Storage 7
Remaining disk size diagnostics 23
Remote Keyboard 50
Remote Sounding Control 9, 28, 50
Remote Transducer Selector 51
Remote Transducer Selector FEEDB (Feedback) 45
Repeaters 9
Repeaters/Slaves 50

S

SCREEN 20, 21, 22
Screen 1, Primary Operation screen 13
Screen 2, 2nd Operation screen. 14
Screen 3, 3rd Operation screen 15
Screen 4, Calendar and clock setting 16
Screen 5, Language and units of measure setup 17
Screen 6, Interface setup screen 18
Screen 7, History Memory Control Screen 19
Screen 8, NMEA control screen 20
Screen 9, System status screen 21
Screen 10, Oscilloscope screen 22
Screen Select 24
Secondary Operation Screens 16
Service 58
SET LOW 17
SIMULATE 21
Simulation PSKP message 53
Simulator 28
Soft Key Functions 25
SOUND 15
SOUND SPD 17
Sound Speed Calibration 9, 29
Specifications 55

Speed 53
Speed indication from GPS 33
Standard System Supply 35
Start-up and system Adaption 51
STATUS 20
Status Screen 28
Status screen diagnosis 32
SYSTEM 14
System Adaptation 51
System Diagram 8
System (Power) On/Off 23
System Summary 6

T

Time 53
Time indication manual or from GPS 33
TRANSDUCER 22
Transducer and Junction Box 57
Transducer Installation 35
Transducer Junction Box 37
Transducer Maintenance 30
Transducers 6
Transducer Selector 63
Transducer Selector Connection 62
Transmitter and Bottom Pulse outputs 46
Trouble Shooting 30
TVG 13, 22, 25
TXT/BIN 28
Typical Oscilloscope Screen (10) Contents 33
Typical Status Screen (9) Contents 31

U

Upgrading Software 60
UPPER 18
User Maintenance 30
Utilization 66

V

VESSEL 15, 21
VESSEL SPD 17
Voltage selection connectors and fuses, terminal board 40

W

Warning 7
Warranty 66

Y

Y(EA)R.MONTH 16